

FDFM2P110

Integrated P-Channel PowerTrench® MOSFET and Schottky Diode

General Description

FDFM2P110 combines the exceptional performance of Fairchild's PowerTrench MOSFET technology with a very low forward voltage drop Schottky barrier rectifier in a MicroFET package.

This device is designed specifically as a single package solution for Buck Boost. It features a fast switching, low gate charge MOSFET with very low on-state resistance.

Applications

- Buck Boost

Features

- -3.5 A, -20 V $R_{DS(ON)} = 140m\Omega @ V_{GS} = -4.5 V$
 $R_{DS(ON)} = 200m\Omega @ V_{GS} = -2.5 V$
- Low Profile - 0.8 mm maximum - in the new package
MicroFET 3x3 mm

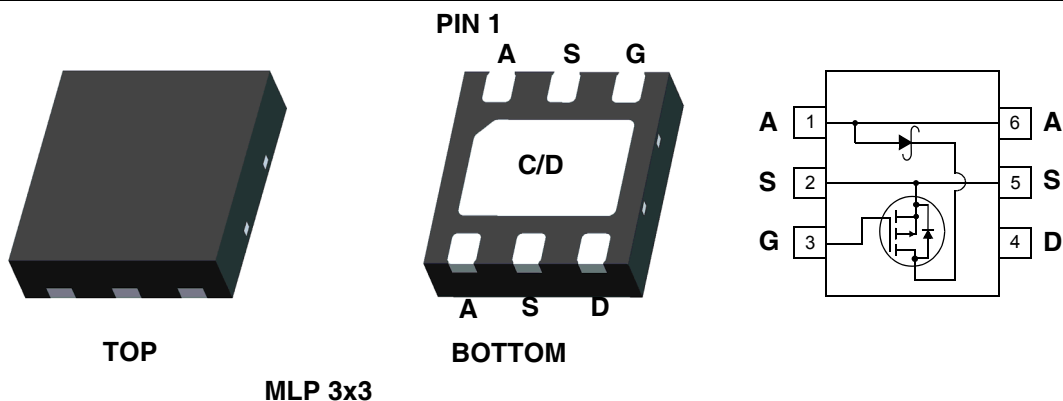

Absolute Maximum Ratings $T_A = 25^\circ C$ unless otherwise noted

Symbol	Parameter	Ratings	Units
V_{DSS}	Drain-Source Voltage	-20	V
V_{GSS}	Gate-Source Voltage	± 12	V
I_D	Drain Current - Continuous (Note 1a)	-3.5	A
	- Pulsed	-10	
V_{RRM}	Schottky Repetitive Peak Reverse voltage	20	V
I_O	Schottky Average Forward Current (Note 1a)	2	A
P_D	Power dissipation (Steady State) (Note 1a)	2	W
		0.8 (Note 1b)	
T_J, T_{STG}	Operating and Storage Junction Temperature Range	-55 to +150	$^\circ C$

Thermal Characteristics

$R_{\theta JA}$	Thermal Resistance, Junction-to-Ambient (Note 1a)	60	$^\circ C/W$
$R_{\theta JA}$	Thermal Resistance, Junction-to-Ambient (Note 1b)	145	$^\circ C/W$

Package Marking and Ordering Information

Device Marking	Device	Reel Size	Tape Width	Quantity
2P110	FDFM2P110	7inch	12mm	3000 units

Electrical Characteristics $T_A = 25^\circ\text{C}$ unless otherwise noted

Symbol	Parameter	Test Conditions	Min	Typ	Max	Units
--------	-----------	-----------------	-----	-----	-----	-------

Off Characteristics

B_{VDSS}	Drain-Source Breakdown Voltage	$I_D = -250\mu\text{A}, V_{GS} = 0\text{V}$	-20	-	-	V
$\frac{\Delta BV_{DSS}}{\Delta T_J}$	Breakdown Voltage Temperature Coefficient	$I_D = -250\mu\text{A}$, Referenced to 25°C	-	-11	-	mV/ $^\circ\text{C}$
I_{DSS}	Zero Gate Voltage Drain Current	$V_{GS} = 0\text{V}, V_{DS} = -16\text{V}$	-	-	-1	μA
I_{GSS}	Gate-Body Leakage,	$V_{GS} = \pm 12\text{V}, V_{DS} = 0\text{V}$	-	-	± 100	nA

On Characteristics (Note 2)

$V_{GS(TH)}$	Gate Threshold Voltage	$V_{DS} = V_{GS}, I_D = -250\mu\text{A}$	-0.6	-1.0	-1.5	V
$\frac{\Delta V_{GS(TH)}}{\Delta T_J}$	Gate Threshold Voltage Temperature Coefficient	$I_D = -250\mu\text{A}$, Referenced to 25°C	-	3	-	mV/ $^\circ\text{C}$
$R_{DS(ON)}$	Static Drain-Source On-Resistance	$I_D = -3.5\text{A}, V_{GS} = -4.5\text{V}$	-	101	140	m Ω
		$I_D = -3.0\text{A}, V_{GS} = -2.5\text{V}$	-	145	200	
		$I_D = -3.5\text{A}, V_{GS} = -4.5\text{V}$, $T_J = 125^\circ\text{C}$	-	136	202	
$I_{D(ON)}$	On-State Drain Current	$V_{GS} = -2.5\text{V}, V_{DS} = -5\text{V}$	-10	-	-	A
g_{FS}	Forward Transconductance	$I_D = -3.5\text{A}, V_{DS} = -5\text{V}$	-	6	-	S

Dynamic Characteristics

C_{ISS}	Input Capacitance	$V_{DS} = -10\text{V}, V_{GS} = 0\text{V}$, $f = 1\text{MHz}$	-	280	-	pF
C_{OSS}	Output Capacitance		-	65	-	pF
C_{RSS}	Reverse Transfer Capacitance		-	35	-	pF
R_G	Gate Resistance	$f = 1\text{MHz}$	-	7	-	Ω

Switching Characteristics (Note 2)

$t_{d(ON)}$	Turn-On Delay Time	$V_{DD} = -10\text{V}, I_D = -1\text{A}$, $V_{GS} = -4.5\text{V}, R_{GEN} = 16\Omega$	-	8	16	ns
t_r	Turn-On Rise Time		-	12	22	ns
$t_{d(OFF)}$	Turn-Off Delay Time		-	11	20	ns
t_f	Turn-Off Fall Time		-	3.2	6.4	ns
Q_g	Total Gate Charge	$V_{DS} = -10\text{V}, I_D = -3.5\text{A}$, $V_{GS} = -4.5\text{V}$	-	3	4	nC
Q_{gs}	Gate-Source Charge		-	0.7	-	nC
Q_{gd}	Gate-Drain Charge		-	1	-	nC

Drain-Source Diode Characteristics and Maximum Ratings

I_S	Maximum Continuous Drain-Source Diode Forward Current	-	-	-2	A	
V_{SD}	Drain-Source Diode Forward Voltage	$V_{GS} = 0\text{V}, I_S = -2\text{A}$ (Note 2)	-	-0.9	-1.2	V
t_{rr}	Diode Reverse Recovery Time	$I_F = -3.5\text{A}, dI_F/dt = 100\text{A}/\mu\text{s}$	-	13	-	ns
Q_{rr}	Diode Reverse Recovery Charge		-	3	-	nC

Schottky Diode Characteristic

V_R	Reverse Voltage	$I_R = 1\text{mA}$	20	-	-	V	
I_R	Reverse Leakage	$V_R = 5\text{V}$	$T_J = 25^\circ\text{C}$	-	-	100	μA
			$T_J = 100^\circ\text{C}$	-	-	10	mA
V_F	Forward Voltage	$I_F = 1\text{A}$	$T_J = 25^\circ\text{C}$	-	0.32	0.39	V

Electrical Characteristics $T_A = 25^\circ\text{C}$ unless otherwise noted

Notes:

1. $R_{\theta JA}$ is the sum of the junction-to-case and case-to-ambient thermal resistance where the case thermal reference is defined as the solder mounting surface of the drain pins. $R_{\theta CA}$ is guaranteed by design while $R_{\theta CA}$ is determined by the user's board design.

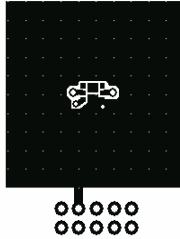

a) 60°C/W when mounted on a 1in^2 pad of 2 oz copper



b) 145°C/W when mounted on a minimum pad of 2 oz copper

Scale 1: 1 on letter size paper

2. Pulse Test: Pulse Width $< 300\ \mu\text{s}$, Duty Cycle $< 2.0\%$

Typical Characteristics

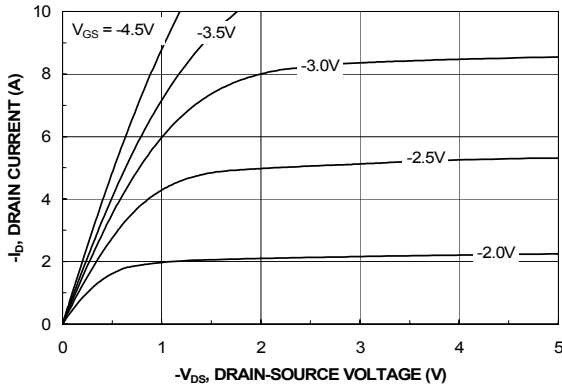

Figure 1. On-Region Characteristics

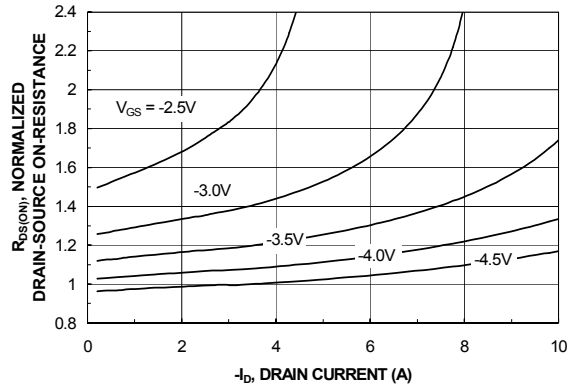

Figure 2. On-Resistance Variation with Drain Current and Gate Voltage

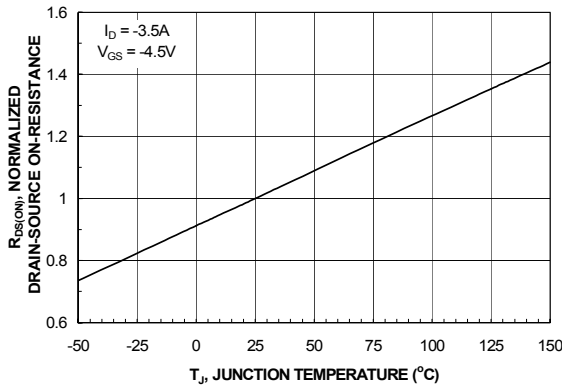

Figure 3. On-Resistance Variation with Temperature

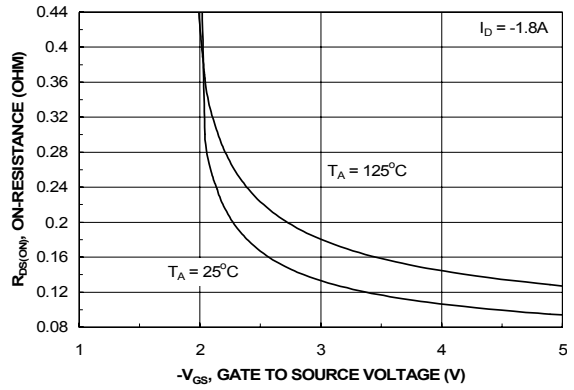

Figure 4. On-Resistance Variation with Gate-to-Source Voltage

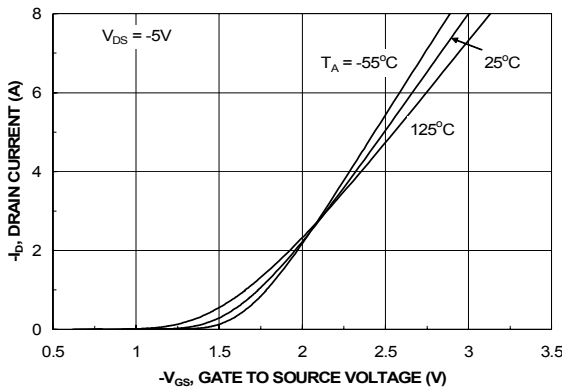

Figure 5. Transfer Characteristics

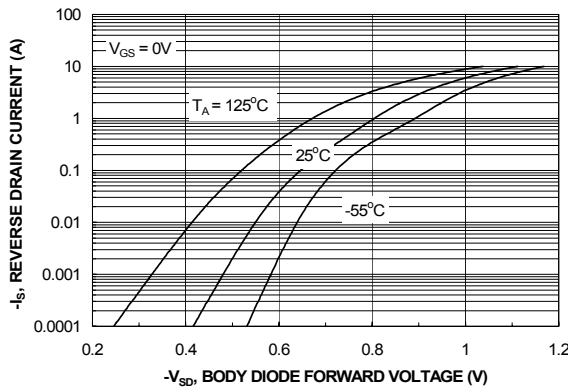

Figure 6. Body Diode Forward Voltage Variation with Source Current and Temperature

Typical Characteristics

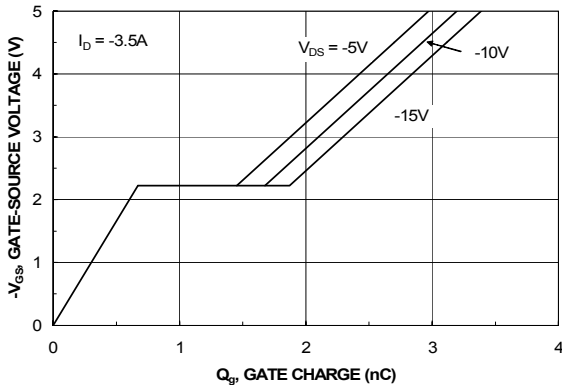

Figure 7. Gate Charge Characteristics

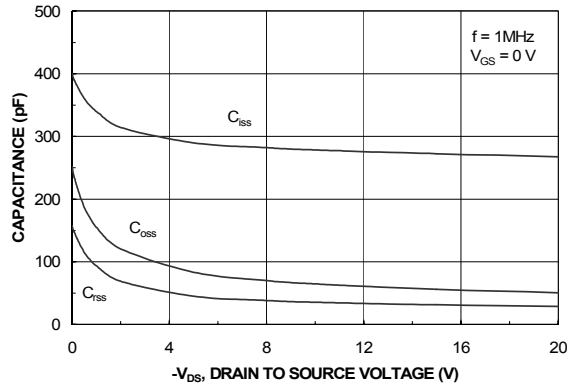

Figure 8. Capacitance Characteristics

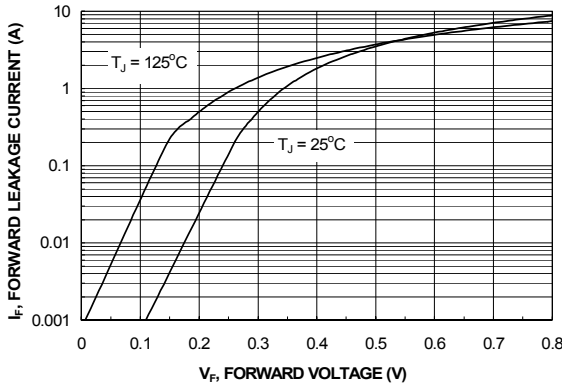

Figure 9. Schottky Diode Forward Voltage

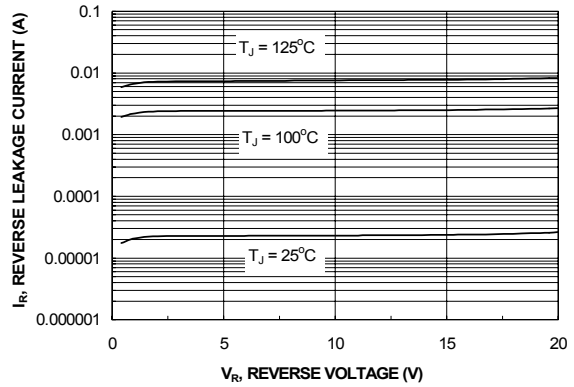

Figure 10. Schottky Diode Reverse Current

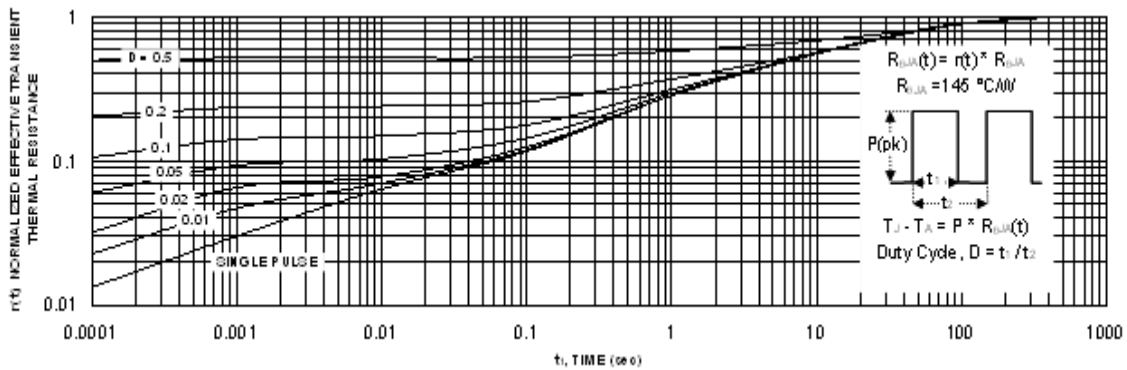
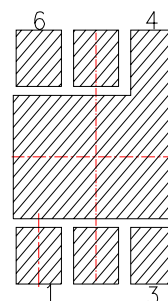
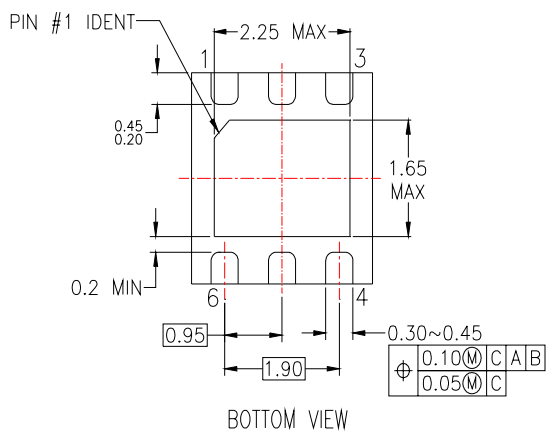
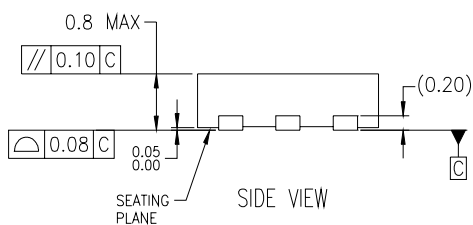
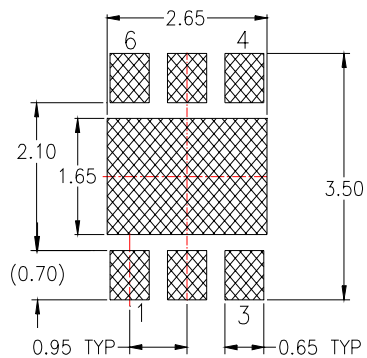
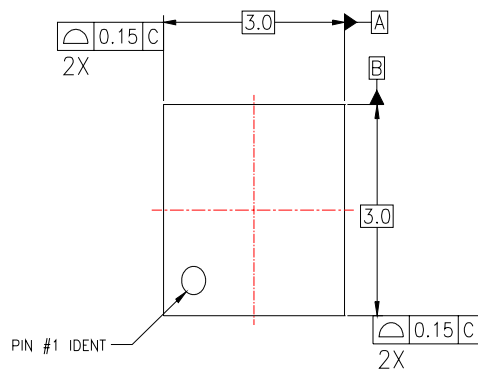

Figure 11. Transient Thermal Response Curve

Thermal characterization performed using the conditions described in Note 1b.
 Transient thermal response will change depending on the circuit board design.



NOTES:

- A. CONFORMS TO JEDEC REGISTRATION MO-229, VARIATION WEEA, DATED 11/2001
- B. DIMENSIONS ARE IN MILLIMETERS.
- C. DIMENSIONS AND TOLERANCES PER ASME Y14.5M, 1994

MLP06GrevA

TRADEMARKS

The following are registered and unregistered trademarks Fairchild Semiconductor owns or is authorized to use and is not intended to be an exhaustive list of all such trademarks.

ACE ^x TM	FACT TM	<i>i-Lo</i> TM	PACMAN TM	SPM TM
ActiveArray TM	FACT Quiet Series TM	ImpliedDisconnect TM	POP TM	Stealth TM
Bottomless TM	FAST [®]	IntelliMAX TM	Power247 TM	SuperFET TM
Build it Now TM	FAST ^r TM	ISOPLANAR TM	PowerEdge TM	SuperSOT TM -3
CoolFET TM	FPST TM	LittleFET TM	PowerSaver TM	SuperSOT TM -6
CROSSVOLT TM	FRFET TM	MICROCOUPLER TM	PowerTrench [®]	SuperSOT TM -8
DOME TM	GlobalOptoisolator TM	MicroFET TM	QFET [®]	SyncFET TM
EcoSPARK TM	GTO TM	MicroPak TM	QS TM	TinyLogic [®]
E ² C ^{MOS} TM	HiSeC TM	MICROWIRE TM	QT Optoelectronics TM	TINYOPTO TM
EnSigna TM	I ² C TM	MSX TM	Quiet Series TM	TruTranslation TM
		MSXPro TM	RapidConfigure TM	UHC TM
Across the board. Around the world. TM		OCX TM	RapidConnect TM	UltraFET [®]
The Power Franchise [®]		OCXPro TM	µSerDes TM	UniFET TM
Programmable Active Droop TM		OPTOLOGIC [®]	SILENT SWITCHER [®]	VCX TM
		OPTOPLANAR TM	SMART START TM	Wire TM

DISCLAIMER

FAIRCHILD SEMICONDUCTOR RESERVES THE RIGHT TO MAKE CHANGES WITHOUT FURTHER NOTICE TO ANY PRODUCTS HEREIN TO IMPROVE RELIABILITY, FUNCTION OR DESIGN. FAIRCHILD DOES NOT ASSUME ANY LIABILITY ARISING OUT OF THE APPLICATION OR USE OF ANY PRODUCT OR CIRCUIT DESCRIBED HEREIN; NEITHER DOES IT CONVEY ANY LICENSE UNDER ITS PATENT RIGHTS, NOR THE RIGHTS OF OTHERS.

LIFE SUPPORT POLICY

FAIRCHILD'S PRODUCTS ARE NOT AUTHORIZED FOR USE AS CRITICAL COMPONENTS IN LIFE SUPPORT DEVICES OR SYSTEMS WITHOUT THE EXPRESS WRITTEN APPROVAL OF FAIRCHILD SEMICONDUCTOR CORPORATION.

As used herein:

- Life support devices or systems are devices or systems which, (a) are intended for surgical implant into the body, or (b) support or sustain life, or (c) whose failure to perform when properly used in accordance with instructions for use provided in the labeling, can be reasonably expected to result in significant injury to the user.
- A critical component is any component of a life support device or system whose failure to perform can be reasonably expected to cause the failure of the life support device or system, or to affect its safety or effectiveness.

PRODUCT STATUS DEFINITIONS

Definition of Terms

Datasheet Identification	Product Status	Definition
Advance Information	Formative or In Design	This datasheet contains the design specifications for product development. Specifications may change in any manner without notice.
Preliminary	First Production	This datasheet contains preliminary data, and supplementary data will be published at a later date. Fairchild Semiconductor reserves the right to make changes at any time without notice in order to improve design.
No Identification Needed	Full Production	This datasheet contains final specifications. Fairchild Semiconductor reserves the right to make changes at any time without notice in order to improve design.
Obsolete	Not In Production	This datasheet contains specifications on a product that has been discontinued by Fairchild semiconductor. The datasheet is printed for reference information only.

Rev. I16