

FDZ1905PZ

Common Drain P-Channel 1.5V PowerTrench® WL-CSP MOSFET

-20V, -3A, 123mΩ

Features

- Max $r_{S1S2(on)}$ = 126mΩ at $V_{GS} = -4.5V$, $I_{S1S2} = -1A$
- Max $r_{S1S2(on)}$ = 141mΩ at $V_{GS} = -2.5V$, $I_{S1S2} = -1A$
- Max $r_{S1S2(on)}$ = 198mΩ at $V_{GS} = -1.8V$, $I_{S1S2} = -1A$
- Max $r_{S1S2(on)}$ = 303mΩ at $V_{GS} = -1.5V$, $I_{S1S2} = -1A$
- Occupies only 1.5 mm² of PCB area, less than 50% of the area of 2 x 2 BGA
- Ultra-thin package: less than 0.65 mm height when mounted to PCB
- High power and current handling capability
- HBM ESD protection level > 4kV (Note 3)
- RoHS Compliant



General Description

This device is designed specifically as a single package solution for the battery charge switch in cellular handset and other ultra-portable applications. It features two common drain P-channel MOSFETs, which enables bidirectional current flow, on Fairchild's advanced 1.5V PowerTrench® process with state of the art "low pitch" WL-CSP packaging process, the FDZ1905PZ minimizes both PCB space and $r_{S1S2(on)}$. This advanced WL-CSP MOSFET embodies a breakthrough in packaging technology which enables the device to combine excellent thermal transfer characteristics, ultra-low profile packaging, low gate charge, and low $r_{S1S2(on)}$.

Applications

- Battery management
- Load switch
- Battery protection

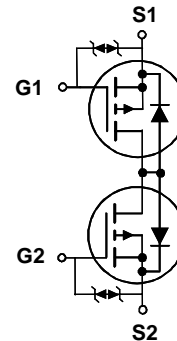
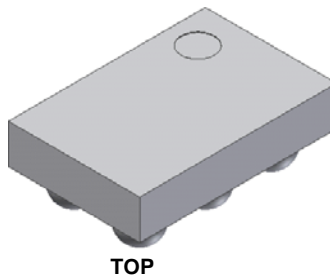
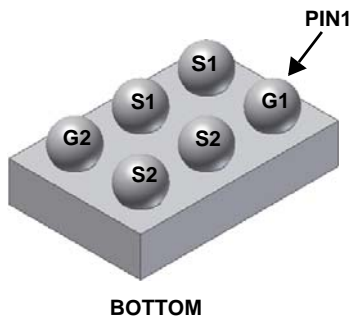

MOSFET Maximum Ratings $T_A = 25^\circ C$ unless otherwise noted

Symbol	Parameter	Conditions	Rated Value	Units
V_{S1S2}	Source1 to Source2 Voltage		-20	V
V_{GS}	Gate to Source Voltage		±8	V
I_{S1S2}	Source1 to Source2 Current	-Continuous $T_A = 25^\circ C$	-3	A
		-Pulsed	-15	
P_D	Power Dissipation (Steady State)	$T_A = 25^\circ C$	1.5	W
	Power Dissipation	$T_A = 25^\circ C$	0.9	
T_J, T_{STG}	Operating and Storage Junction Temperature Range		-55 to +150	$^\circ C$

Thermal Characteristics

$R_{\theta JA}$	Thermal Resistance, Junction to Ambient	(Note 1a)	83	$^\circ C/W$
$R_{\theta JA}$	Thermal Resistance, Junction to Ambient	(Note 1b)	140	

Package Marking and Ordering Information

Device Marking	Device	Package	Reel Size	Tape Width	Quantity
5	FDZ1905PZ	WL-CSP 1.0X1.5	7"	8mm	5000 units

Electrical Characteristics $T_J = 25^\circ\text{C}$ unless otherwise noted

Symbol	Parameter	Test Conditions	Min	Typ	Max	Units
--------	-----------	-----------------	-----	-----	-----	-------

Off Characteristics

I_{S1S2}	Zero Gate Voltage Source1 to Source2 Current	$V_{S1S2} = -16\text{V}, V_{GS} = 0\text{V}$			-1	μA
I_{GSS}	Gate Body Leakage Current	$V_{GS} = \pm 8\text{V}, V_{S1S2} = 0\text{V}$			± 10	μA

On Characteristics (Note 2)

$V_{GS(th)}$	Gate to Source Threshold Voltage	$V_{GS} = V_{S1S2}, I_{S1S2} = -250\mu\text{A}$	-0.4	-0.7	-1.0	V
$r_{S1S2(on)}$	Static Source1 to Source2 On Resistance	$V_{GS} = -4.5\text{V}, I_{S1S2} = -1\text{A}$		99	126	m Ω
		$V_{GS} = -2.5\text{V}, I_{S1S2} = -1\text{A}$		112	141	
		$V_{GS} = -1.8\text{V}, I_{S1S2} = -1\text{A}$		132	198	
		$V_{GS} = -1.5\text{V}, I_{S1S2} = -1\text{A}$		164	303	
		$V_{GS} = -4.5\text{V}, I_{S1S2} = -1\text{A}, T_J = 125^\circ\text{C}$		135	195	
g_{FS}	Forward Transconductance	$V_{S1S2} = -5\text{V}, I_{S1S2} = -1\text{A}$		8		S

Switching Characteristics (Note 2)

$t_{d(on)}$	Turn-On Delay Time	$V_{S1S2} = -10\text{V}, I_{S1S2} = -1\text{A}$ $V_{GS} = -4.5\text{V}, R_{GEN} = 6\Omega$		12	22	ns
t_r	Rise Time			36	58	ns
$t_{d(off)}$	Turn-Off Delay Time			143	229	ns
t_f	Fall Time			182	291	ns

Notes:

1. $R_{\theta JA}$ is determined with the device mounted on a 1in^2 pad 2 oz copper pad on a $1.5 \times 1.5\text{in.}$ board of FR-4 material. $R_{\theta JC}$ is guaranteed by design while $R_{\theta CA}$ is determined by the user's board design.

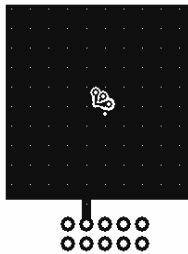

a. 83°C/W when mounted on a 1in^2 pad of 2 oz copper

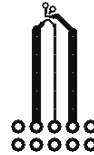

b. 140°C/W when mounted on a minimum pad of 2 oz copper

2. Pulse Test: Pulse Width < 300ms, Duty cycle < 2.0%.

3. The diode connected between the gate and source serves only protection against ESD. No gate overvoltage rating is implied.

Typical Characteristics $T_J = 25^\circ\text{C}$ unless otherwise noted

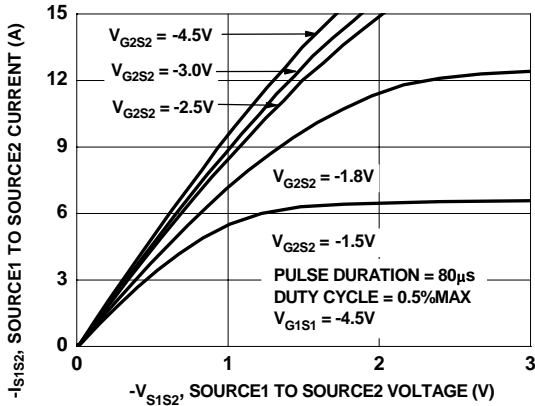

Figure 1. On Region Characteristics

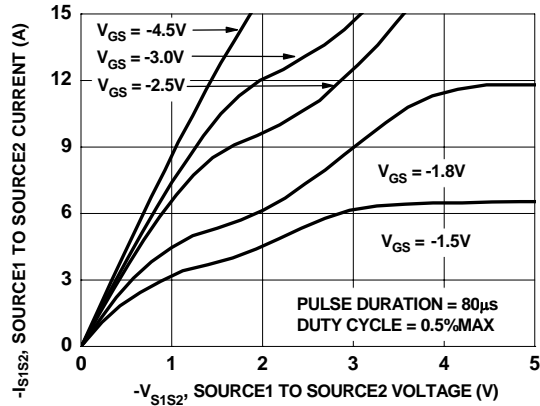

Figure 2. On Region Characteristics

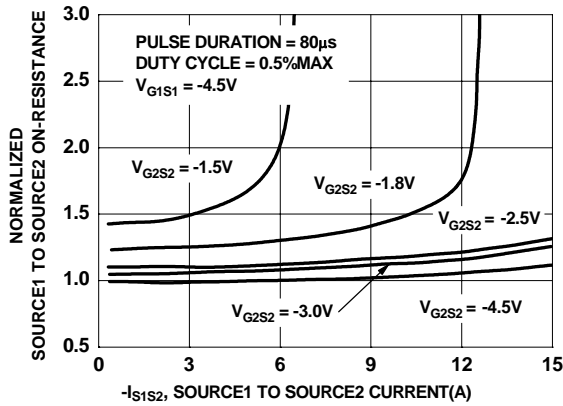

Figure 3. Normalized On-Resistance vs Drain Current and Gate Voltage

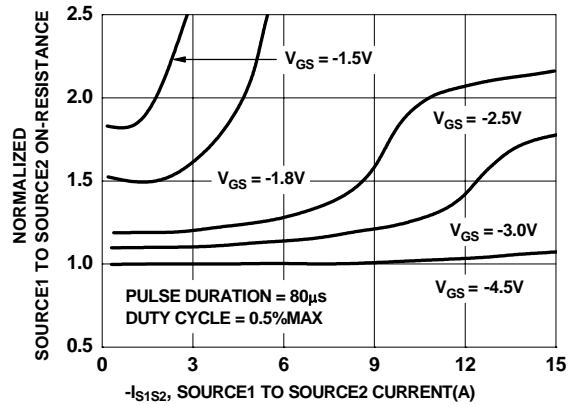

Figure 4. Normalized On-Resistance vs Drain Current and Gate Voltage

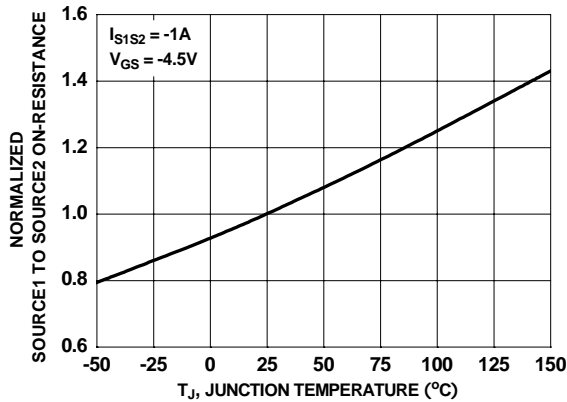

Figure 5. Normalized On Resistance vs Junction Temperature

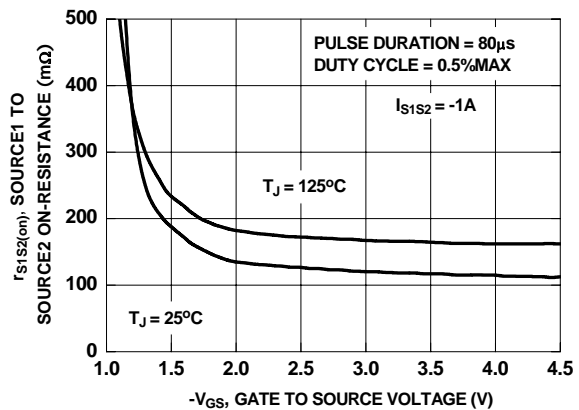

Figure 6. On-Resistance vs Gate to Source Voltage

Typical Characteristics $T_J = 25^\circ\text{C}$ unless otherwise noted

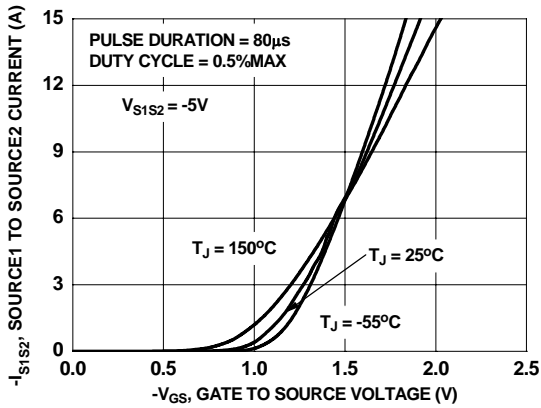

Figure 7. Transfer Characteristics

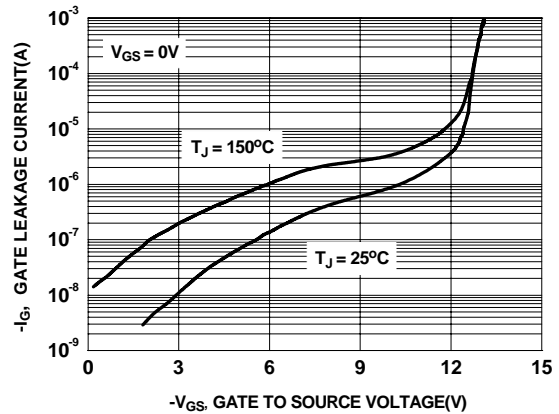

Figure 8. Gate Leakage vs. Gate to Source Voltage

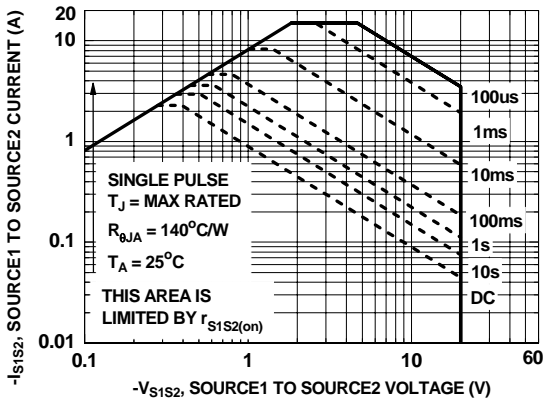

Figure 9. Forward Bias Safe Operating Area

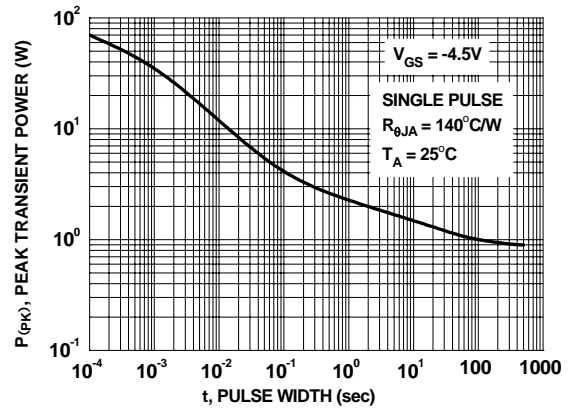

Figure 10. Single Pulse Maximum Power Dissipation

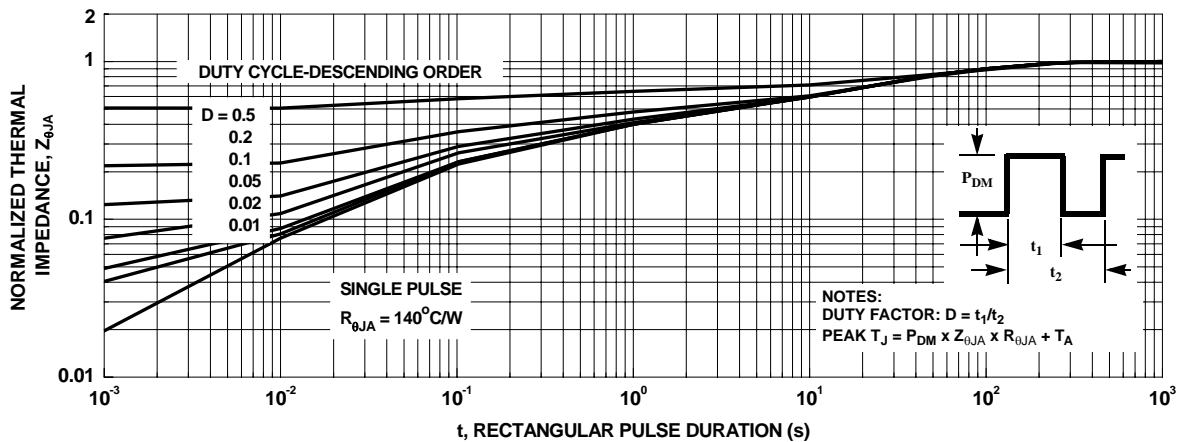
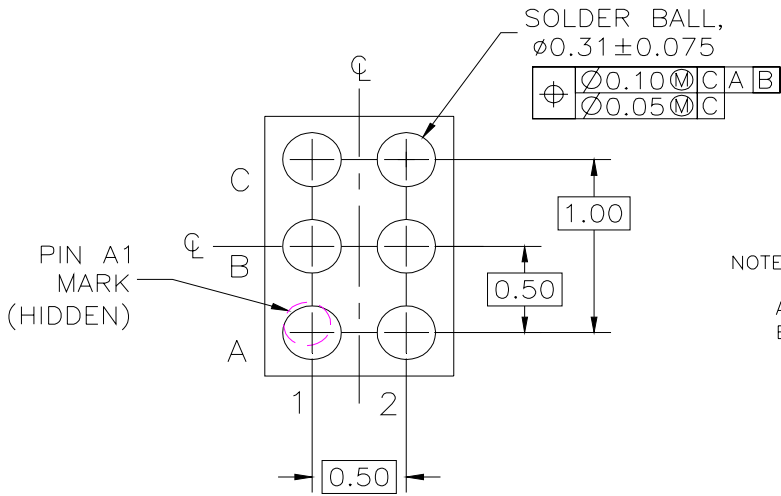
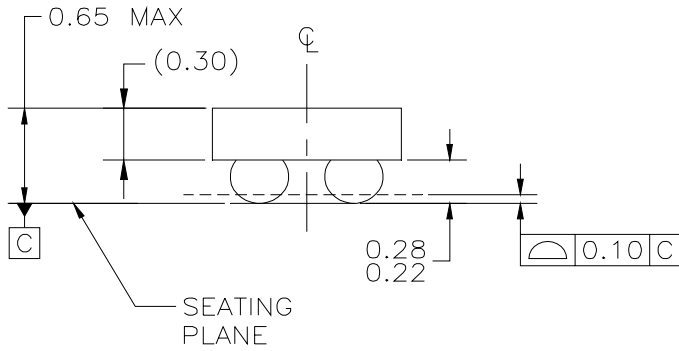
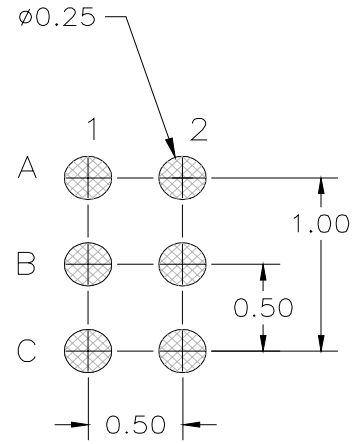
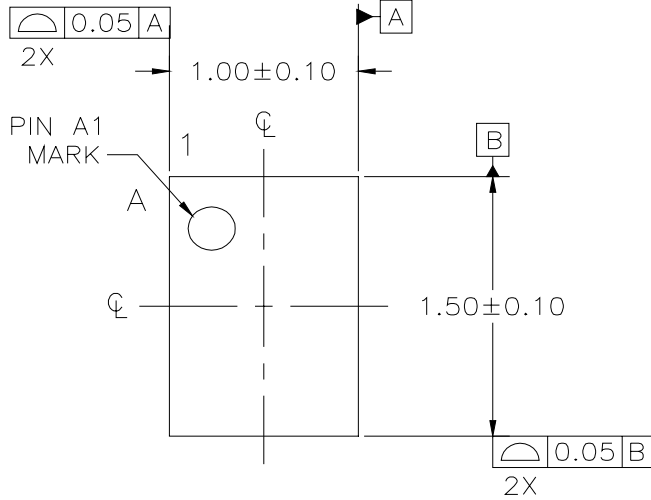

Figure 11. Transient Thermal Response Curve



NOTES: UNLESS OTHERWISE SPECIFIED





- A) ALL DIMENSIONS ARE IN MILLIMETERS.
- B) NO JEDEC REGISTRATION REFERENCE AS OF OCTOBER 2005.

UC006AAREVC

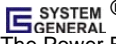

TRADEMARKS

The following includes registered and unregistered trademarks and service marks, owned by Fairchild Semiconductor and/or its global subsidiaries, and is not intended to be an exhaustive list of all such trademarks.

- | | | | |
|---|---|----------------------------|---|
| ACEX® | FPS™ | PDP-SPM™ | SupreMOS™ |
| Build it Now™ | FRFET® | Power220® | SyncFET™ |
| CorePLUS™ | Global Power Resource SM | POWEREDGE® |  SYSTEM GENERAL® |
| CROSSVOLT™ | Green FPST™ | Power-SPM™ | The Power Franchise® |
| CTL™ | Green FPST™ e-Series™ | PowerTrench® |  the power franchise |
| Current Transfer Logic™ | GTO™ | Programmable Active Droop™ | TinyBoost™ |
| EcoSPARK® | i-Lo™ | QFET® | TinyBuck™ |
| EZSWITCH™ * | IntelliMAX™ | QS™ | TinyLogic® |
|  | ISOPLANAR™ | QT Optoelectronics™ | TINYOPTO™ |
|  | MegaBuck™ | Quiet Series™ | TinyPower™ |
| Fairchild® | MICROCOUPLER™ | RapidConfigure™ | TinyPWM™ |
| Fairchild Semiconductor® | MicroFET™ | SMART START™ | TinyWire™ |
| FACT Quiet Series™ | MicroPak™ | SPM® | µSerDes™ |
| FACT® | MillerDrive™ | STEALTH™ | UHC® |
| FAST® | Motion-SPM™ | SuperFET™ | Ultra FRFET™ |
| FastvCore™ | OPTOLOGIC® | SuperSOT™-3 | UniFET™ |
| FlashWriter® * | OPTOPLANAR® | SuperSOT™-6 | VCX™ |
| |  | SuperSOT™-8 | |

* EZSWITCH™ and FlashWriter® are trademarks of System General Corporation, used under license by Fairchild Semiconductor.

DISCLAIMER

FAIRCHILD SEMICONDUCTOR RESERVES THE RIGHT TO MAKE CHANGES WITHOUT NOTICE TO ANY PRODUCTS HEREIN TO IMPROVE RELIABILITY, FUNCTION, OR DESIGN. FAIRCHILD DOES NOT ASSUME ANY LIABILITY ARISING OUT OF THE APPLICATION OR USE OF ANY PRODUCT OR CIRCUIT DESCRIBED HEREIN; NEITHER DOES IT CONVEY ANY LICENSE UNDER ITS PATENT RIGHTS, NOR THE RIGHTS OF OTHERS. THESE SPECIFICATIONS DO NOT EXPAND THE TERMS OF FAIRCHILD'S WORLDWIDE TERMS AND CONDITIONS, SPECIFICALLY THE WARRANTY THEREIN, WHICH COVERS THESE PRODUCTS.

LIFE SUPPORT POLICY

FAIRCHILD'S PRODUCTS ARE NOT AUTHORIZED FOR USE AS CRITICAL COMPONENTS IN LIFE SUPPORT DEVICES OR SYSTEMS WITHOUT THE EXPRESS WRITTEN APPROVAL OF FAIRCHILD SEMICONDUCTOR CORPORATION.

As used herein:

- Life support devices or systems are devices or systems which, (a) are intended for surgical implant into the body or (b) support or sustain life, and (c) whose failure to perform when properly used in accordance with instructions for use provided in the labeling, can be reasonably expected to result in a significant injury to the user.
- A critical component in any component of a life support, device or system whose failure to perform can be reasonably expected to cause the failure of the life support device or system, or to affect its safety or effectiveness.

PRODUCT STATUS DEFINITIONS

Definition of Terms

Datasheet Identification	Product Status	Definition
Advance Information	Formative or In Design	This datasheet contains the design specifications for product development. Specifications may change in any manner without notice.
Preliminary	First Production	This datasheet contains preliminary data; supplementary data will be published at a later date. Fairchild Semiconductor reserves the right to make changes at any time without notice to improve design.
No Identification Needed	Full Production	This datasheet contains final specifications. Fairchild Semiconductor reserves the right to make changes at any time without notice to improve design.
Obsolete	Not In Production	This datasheet contains specifications on a product that has been discontinued by Fairchild Semiconductor. The datasheet is printed for reference information only.