



FL7701

Smart LED Lamp Driver IC with PFC Function

Features

- Digitally Implemented Active PFC Function (No Additional Circuit Necessary for High PF)
- Built-in HV Supplying Circuit: Self Biasing
- Application Input Range :80V_{AC} ~ 308V_{AC}
- AOCF Function with Auto-Restart Mode
- Built-in Over-Temperature Protection Function
- Cycle-by-Cycle Current Limit
- Current-Sense Pin Open Protection
- Low Operating Current: 0.85mA (Typical)
- Under-Voltage Lockout with 5V Hysteresis
- Programmable Oscillation Frequency
- Programmable LED Current
- Analog Dimming Function
- Soft-Start Function
- Precise Internal Reference: ±3%

Description

The FL7701 LED lamp driver is a simple IC with PFC function. The special “adopted digital” technique of the IC can automatically detect input voltage condition and send an internal reference signal for achieving high power factor. When AC input is applied to the IC, PFC function is automatically enabled. Otherwise, when DC input is applied to the IC, PFC function is automatically disabled. The FL7701 does not need a bulk capacitor (electrolytic capacitor) for supply rail stability, which can significantly affect to LED lamp system.

Related Resources

- [Evaluation Board: FEBFL7701_L30U003A](#)

Applications

- LED Lamp for Decorative Lighting
- LED Lamp for Low-Power Lighting

Ordering Information

Part Number	Operating Temperature Range	Package	Packing Method
FL7701M	-40°C to +125°C	8-Lead, Small Outline Integrated Circuit (SOIC), JEDEC MS-012, .150-inch Narrow Body	Tube
FL7701MX			Tape & Reel

Application Diagram

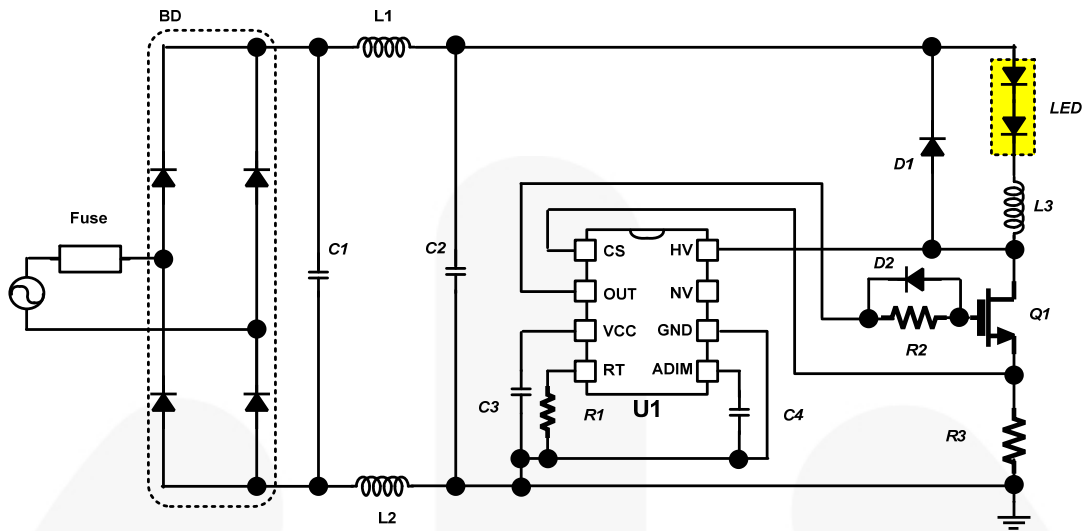

Figure 1. Typical Application

Block Diagram

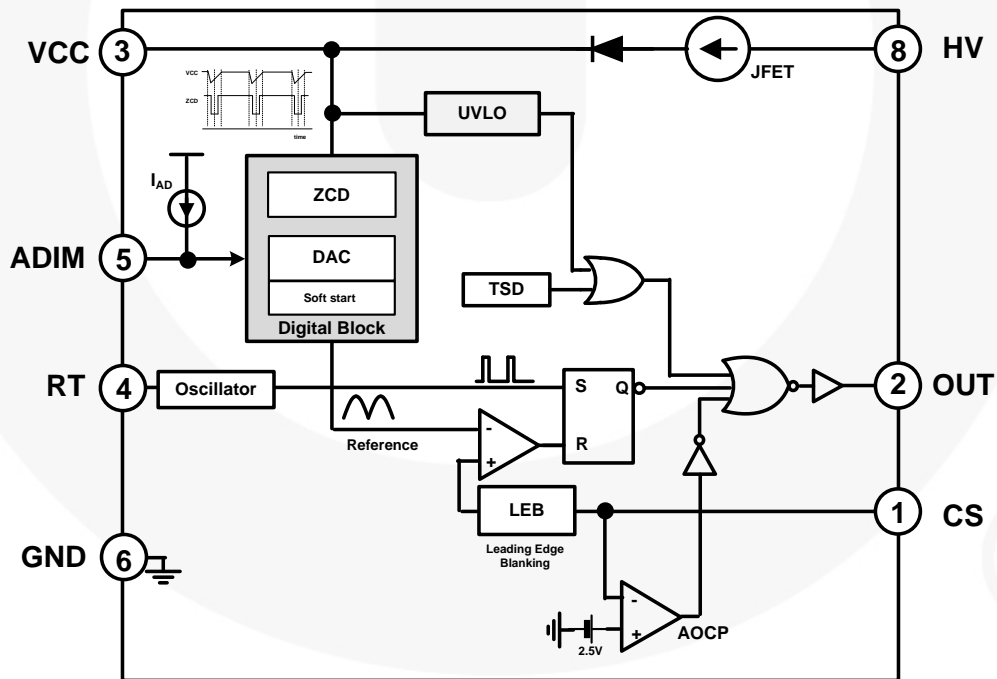

Figure 2. Block Diagram

Pin Configuration

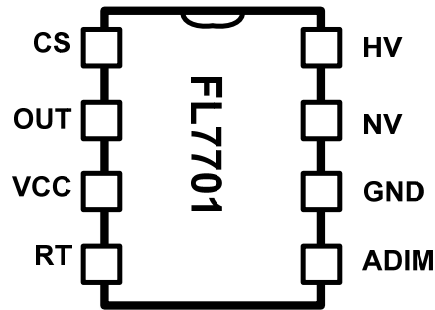

Figure 3. Pin Configuration

Pin Definitions

Pin #	Name	Description
1	CS	Current Sense. Limits output current depending on the sensing resistor voltage. The CS pin is also used to set the LED current regulation
2	OUT	OUT. Connects to the MOSFET gate.
3	VCC	VCC. Supply pin for stable IC operation ZCD signal detection used for accurate PFC function.
4	RT	RT. Programmable operating frequency using external resistor and the IC has pre-fixed frequency when this pin is open or floating.
5	ADIM	Analog Dimming. Connect to the internal current source and can change the output current using an external resistor. If ADIM is not used, it is recommended to connect a 0.1 μ F bypass capacitor between the ADIM and GND.
6	GND	GROUND. Ground for the IC.
7	NC	No Connection
8	HV	High Voltage. Connect to the high voltage line and supply current to the IC

Absolute Maximum Ratings

Stresses exceeding the absolute maximum ratings may damage the device. The device may not function or be operable above the recommended operating conditions and stressing the parts to these levels is not recommended. In addition, extended exposure to stresses above the recommended operating conditions may affect device reliability. The absolute maximum ratings are stress ratings only.

Symbol	Parameter	Min.	Max.	Unit
V_{CC}	IC Supply Voltage		20	V
HV	High Voltage Sensing		500	V
I_{O+}/I_{O-}	Peak Drive Output Current (Sourcing / Sinking)		250	mA
V_{ADIM}	Analog Dimming		5	V
V_{RT}	RT Pin Voltage		5	V
V_{CS}	Allowable Current Sensing Detection Voltage		5	V
T_A	Operating Ambient Temperature Range	-40	+125	°C
T_J	Operating Junction Temperature	-40	+150	°C
T_{STG}	Storage Temperature Range	-65	+150	°C
θ_{JA}	Thermal Resistance Junction-Air ^(1,2)		135	°C/W
P_D	Power Dissipation		660	mW
ESD	Electrostatic Discharge Capability	Human Body Model, JESD22-A114	2000	V
		Charged Device Model, JESD22-C101	1000	

Notes:

1. Thermal resistance test board. Size: 76.2mm x 114.3mm x 1.6mm (1S0P); JEDEC standard: JESD51-2, JESD51-3.
2. Assume no ambient airflow.

Electrical Characteristics

Typical values are at $T_A = +25^\circ\text{C}$. Specifications to $-40^\circ\text{C} \sim 125^\circ\text{C}$ are guaranteed by design based on final characterization results.

Symbol	Parameter	Conditions	Min.	Typ.	Max.	Unit
V_{CC} Bias Section						
V _{CC}	VCC Regulator Output Voltage	V _{HV} =100V _{dc}	14.0	15.5	17.0	V
V _{CCST+}	UVLO Positive Going Threshold	V _{CC} Increasing	12	13	14	V
V _{CCST-}	UVLO Negative Going Threshold	V _{CC} Decreasing	7	8	9	V
V _{CCHY}	UVLO Hysteresis		4	5	6	V
I _{HV}	HV Pin Current	V _{HV} =100V _{DC} , C _L =150pF, RT=Open		0.85	1.10	mA
I _{ST}	Startup Current			120	150	μA
Switching Section						
f _{OSC}	Operating Frequency	R _T =5.95kΩ	200	250	300	kHz
		R _T =87kΩ	16	20	24	kHz
		R _T Open	40.5	45.0	49.5	kHz
t _{MIN}	Minimum On Time		400		ns	
D _{MAX}	Maximum Duty Cycle		50		%	
t _{LEB}	Leading Edge Blanking Time ⁽³⁾			350		ns
V _{RT}	Voltage Reference of RT pin			1.5		V
Soft-Start Section						
t _{SS}	Soft-Start Time ⁽³⁾	DC Mode	48	60	72	ms
		AC Mode		7		Periods
Reference Section						
V _{CS1}	Internal Reference Voltage of CS Pin	DC Mode	0.354	0.365	0.376	V
V _{CS2}		AC Mode ⁽³⁾	0.485	0.500	0.515	
Protection Section						
OVP _{VCC}	Over-Voltage Protection on VCC Pin		17.7	18.7	19.7	V
V _{AACP}	Abnormal OCP Level at CS Pin ⁽³⁾			2.5		V
t _{AACP}	Abnormal Detection Time ⁽³⁾			70		ns
t _{TSDH}	Thermal Shutdown Threshold ⁽³⁾		140	150		°C
t _{TSDHY}	Thermal Shutdown Threshold Hysteresis ⁽³⁾			50		°C
Dimming Section						
V _{ADIM(ST+)}	Analog Dimming Positive Going Threshold ⁽³⁾		3.15	3.50	3.85	V
V _{ADIM(ST-)}	Analog Dimming Negative Going Threshold ⁽³⁾			0.50	0.75	V
I _{AD}	Internal Current Source for ADIM Pin		9	12	15	μA

Note:

3. These parameters, although guaranteed, are not 100% tested in production.

Functional Description

The FL7701 is a basic PWM controller for buck converter topology in Continuous Conduction Mode (CCM) with intelligent PFC function using a digital control algorithm. The FL7701 has an internal self-biasing circuit that uses the high-voltage switching device. The IC does not need an auxiliary powering path to the VCC pin typical in flyback control ICs or PSR product family.

When the input voltage applied to the HV pin is over 25V to 500V, the FL7701 maintains a 15.5V DC voltage at the VCC pin for stable operation. The FL7701 has UVLO block functions such that when the V_{CC} voltage rises higher than V_{CCST+} , the internal UVLO block releases and starts operation. Otherwise the VCC goes down to the V_{CCST-} and IC operation stops. Normally, the hysteresis function provides stable operation even if the input voltage is operating under the very noisy or unstable circumstances.

The FL7701 has a smart internal digital block for determining input condition: AC or DC. When an AC source with 50Hz or 60Hz is applied to the IC, the IC automatically changes its internal reference signal, which is similar to input signal, for creating high power factor. Otherwise, once the DC source connects to the IC, the internal reference immediately changes to DC.

1. Soft-Start Function

The FL7701 has an internal soft-start function to reduce inrush current at startup. When the IC starts operation following an internal sequence, the internal reference slowly increases for a pre-determined fixed time. After this transient period, the internal reference goes to a steady-state level. In this time, the IC continually tries to find phase information from the VCC pin. If the IC succeeds in getting phase information, it automatically follows a similar shape reference made during the transient times, 7 periods. If not, the IC has a DC reference level.

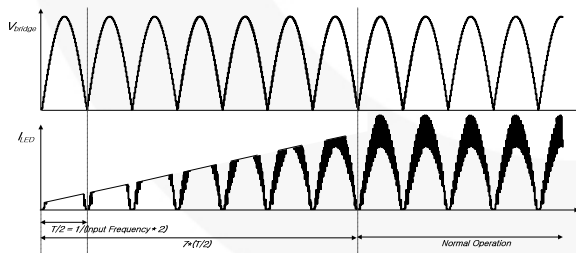

Figure 4. Soft Starting Function in AC Input Mode

2. Internal PFC Function: How to Achieve High Power Factor

The FL7701 has a simple, but smart, internal PFC function that does not require additional detection pins for detecting input phase information or an electrolytic capacitor for supply voltage stabilization. For achieving high PF, the FL7701 does not use the rectification capacitor after the bridge diode. This is important

because the IC instead uses fluctuation in the signal on the VCC pin. Basically, the VCC pin, which supplies power for the IC, has voltage ripple as well as the rectification voltage after bridge, changing voltage level according to the VCC capacitor value. Using this kind of voltage fluctuation on the VCC pin, the IC can detect the time reference and create the internal ZCD signal.

For precise and reliable internal reference for input voltage signal, the FL7701 uses a digital technique (sigma/delta modulation) and creates a new internal signal (DAC_OUT) that has the same phase as the input voltage, as shown in Figure 5. This signal enters the final comparator and is compared with current information from the sensing resistor.

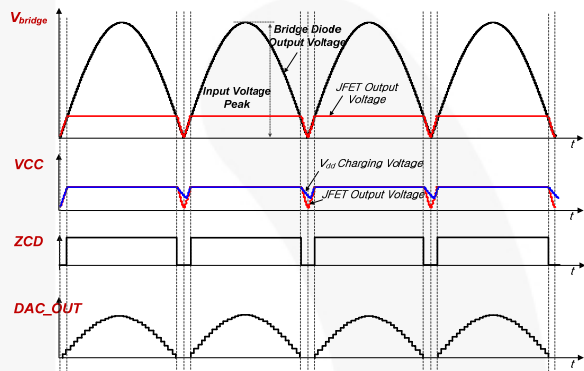

Figure 5. Internal PFC Function

3. Self-Biasing Function

The self-biasing function, using an HV device, can supply enough operating current to the IC and guarantee similar startup time across the whole input voltage range (80V~308V_{AC}). However, self-biasing has a weakness in high-voltage condition. Normally, the HV device acts as constant current source, so the internal HV device has power loss when high input voltage connects to the HV pin. This power loss is proportional to input voltage. To reduce this power loss, one of the possible solutions is an additional resistor between the input voltage source and the HV pin, as shown in Figure 6.

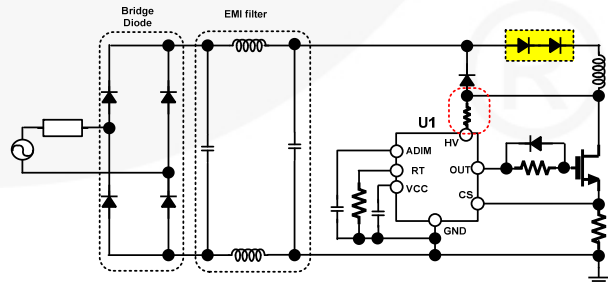

Figure 6. High-Voltage Application

4. Dimming Function

The FL7701 uses the ADIM pin for analog or 0V to 10V dimming. The peak voltage of internal reference, which is DAC_OUT signal in Figure 5, is changed by the V_{ADIM} level, as shown in Figure 7, and has different peak level according to the operating mode.

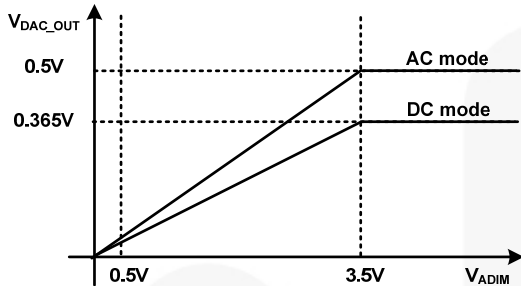

Figure 7. V_{ADIM} vs. V_{DAC_OUT(peak)}

5. Inductor Design

The FL7701 prefixed internal duty ratio range is below 50%, or around 400ns, from timing point of view. The range is dependent on the input voltage and LED numbers in its string.

Minimum duty is calculated as:

$$D_{min} = \frac{n \cdot V_f}{\eta \cdot V_{in(max)}} \quad (1)$$

where:

- η is efficiency of system;
- V_{IN(max)} is maximum input voltage;
- V_f is forward drop voltage of LED; and
- n is LED number in series connection.

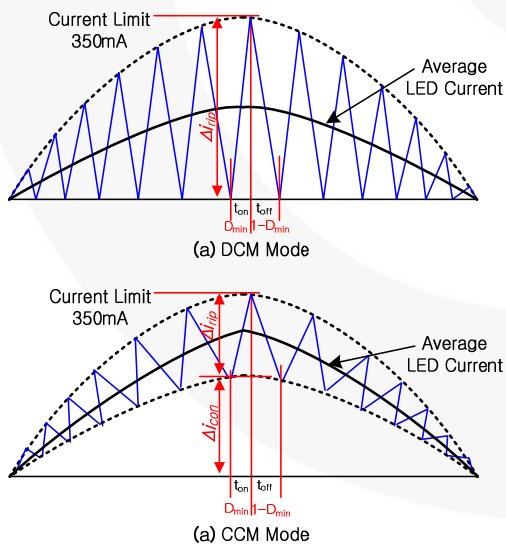

Figure 8. DCM and CCM Operation

In DCM Mode, inductance is:

$$L_m = \frac{n \cdot V_f \cdot (1 - D_{min})}{f_s \cdot \Delta i_{rip}} [H] \quad (2)$$

If the peak current is fixed at 350mA_{pk}, the formula for the peak current is:

$$I_{o(peak)} = \Delta i_{con} + \frac{\Delta i_{rip}}{2} = 350 [mA] \quad (3)$$

In FL7701, the LED RMS current determines the inductance parameter. To drive for CCM Mode, define LED RMS current first, as:

$$I_{o(rms)} = \Delta i_{rip} - \frac{\Delta i_{rip}}{2} [mA] \quad (4)$$

Substituting Equation 2 for Equation 4, the inductance of inductor is obtained.

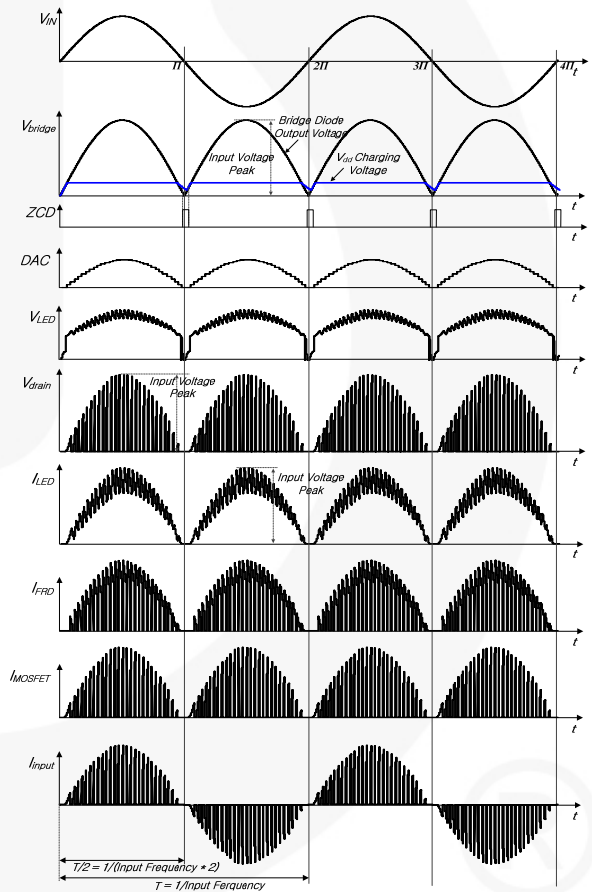

Figure 9. Typical Performance Characteristics

Example Application Circuits

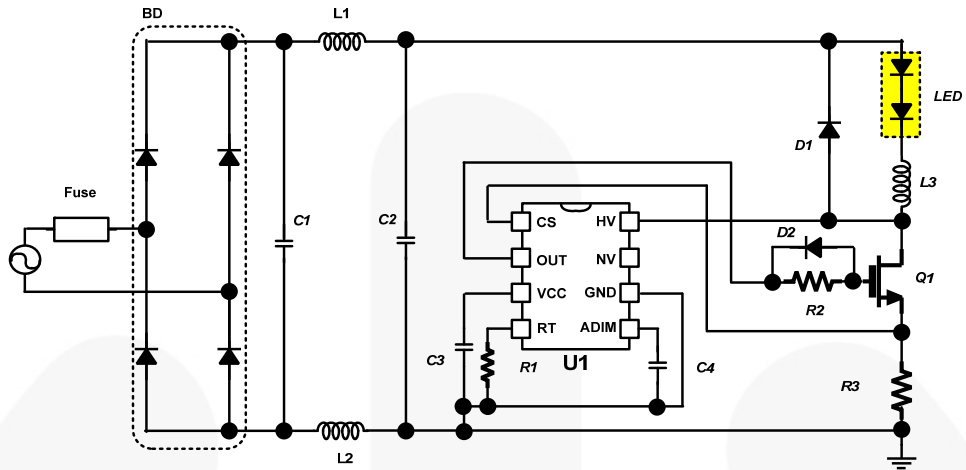

Figure 10. Application without an Electrolytic Capacitor

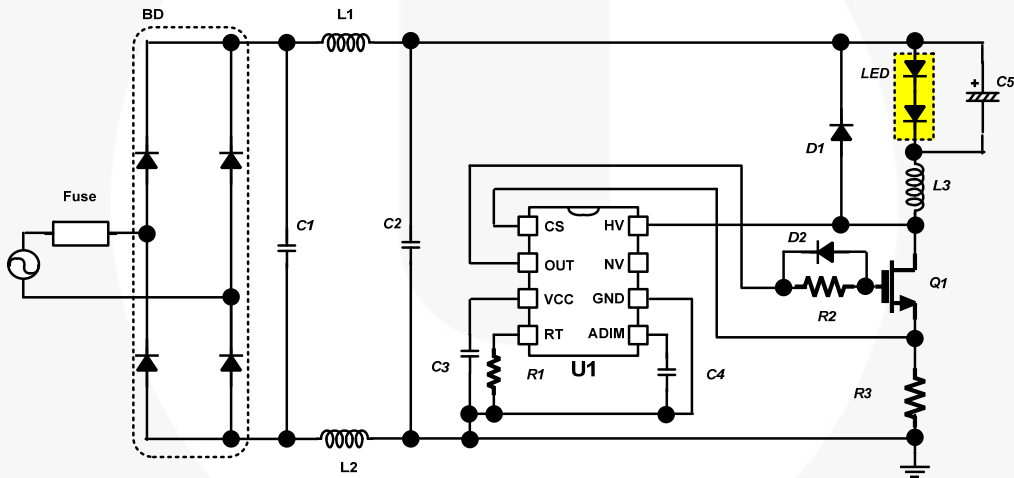

Figure 11. Application with an Electrolytic Capacitor

Typical Characteristics

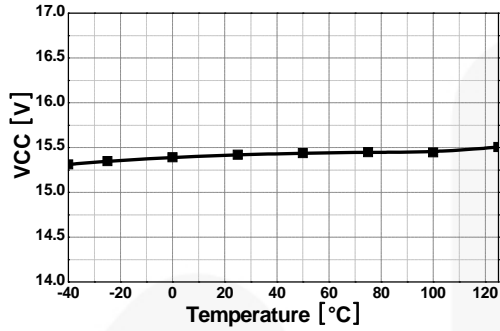

Figure 12. V_{CC} vs. Temperature

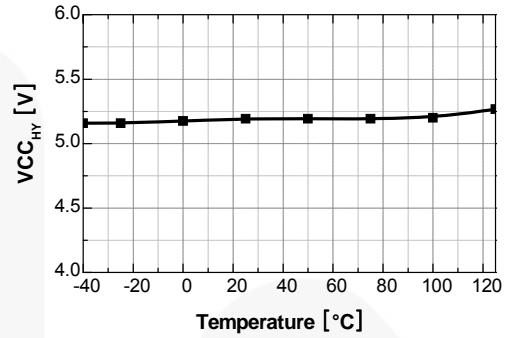

Figure 13. VCC_{HY} vs. Temperature

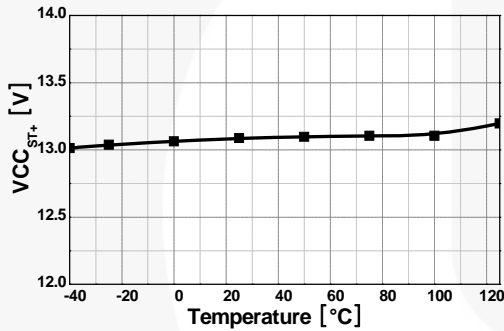

Figure 14. VCC_{ST+} vs. Temperature

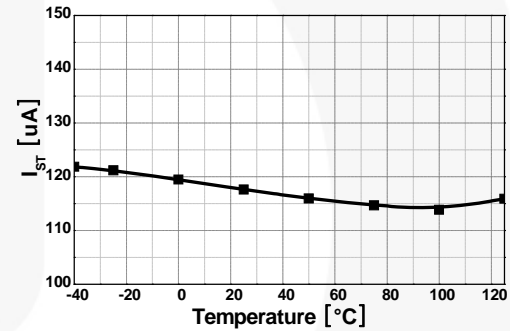

Figure 15. I_{ST} vs. Temperature

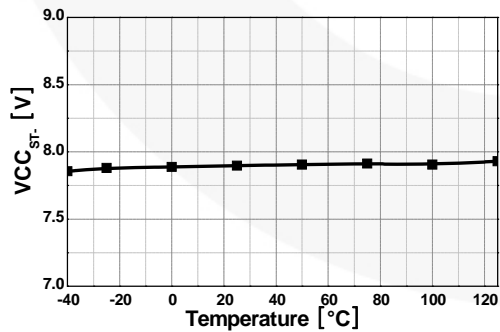

Figure 16. VCC_{ST-} vs. Temperature

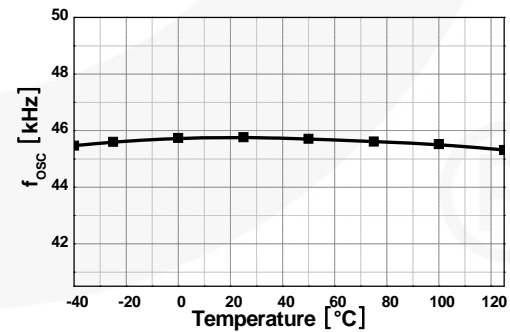

Figure 17. f_{osc} vs. Temperature (R_t=Open)

Typical Characteristics

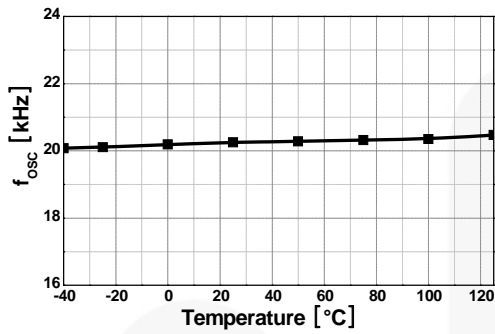

Figure 18. f_{osc} vs. Temperature ($R_t=87k\Omega$)

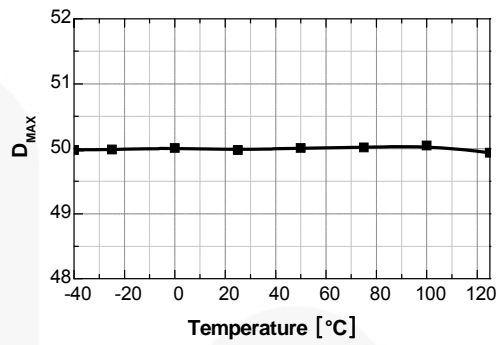

Figure 19. D_{MAX} vs. Temperature

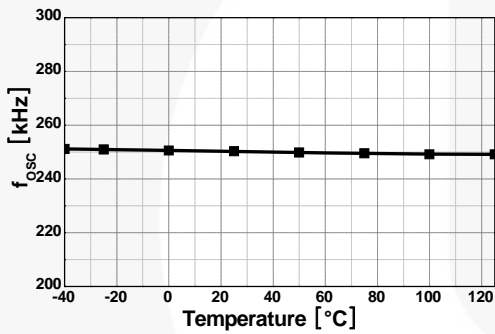

Figure 20. f_{osc} vs. Temperature ($R_t=5.95k\Omega$)

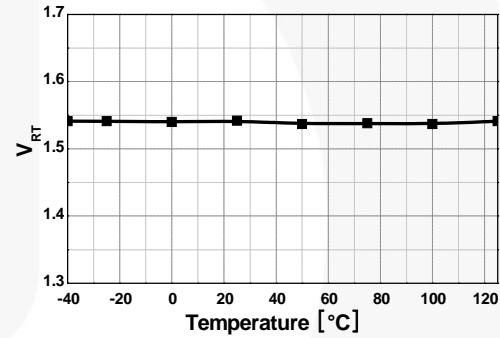

Figure 21. V_{RT} vs. Temperature

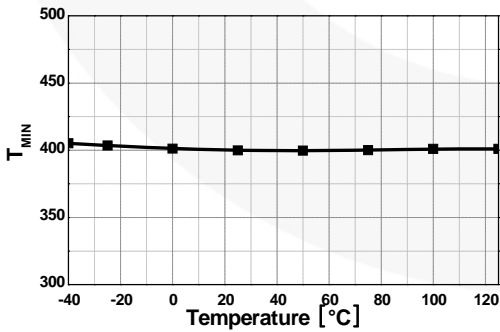

Figure 22. t_{MIN} vs. Temperature

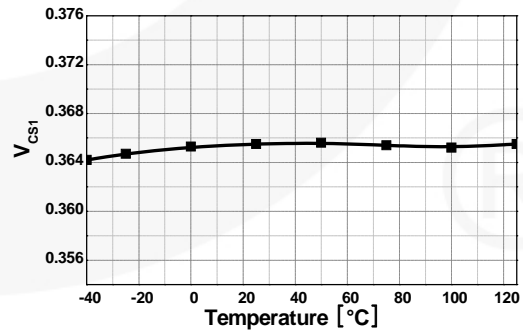

Figure 23. V_{CS1} vs. Temperature

Typical Characteristics

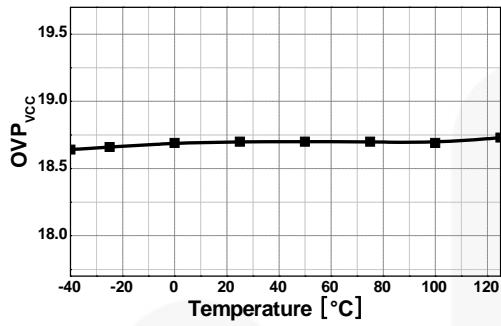

Figure 24. OVP_VCC vs. Temperature

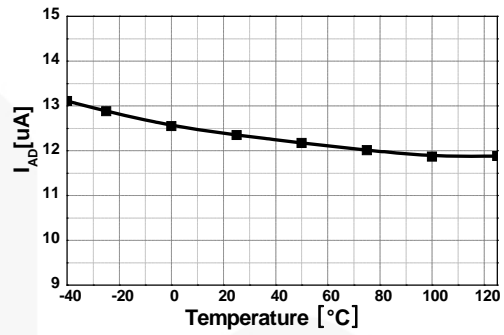

Figure 25. I_AD vs. Temperature



Physical Dimensions

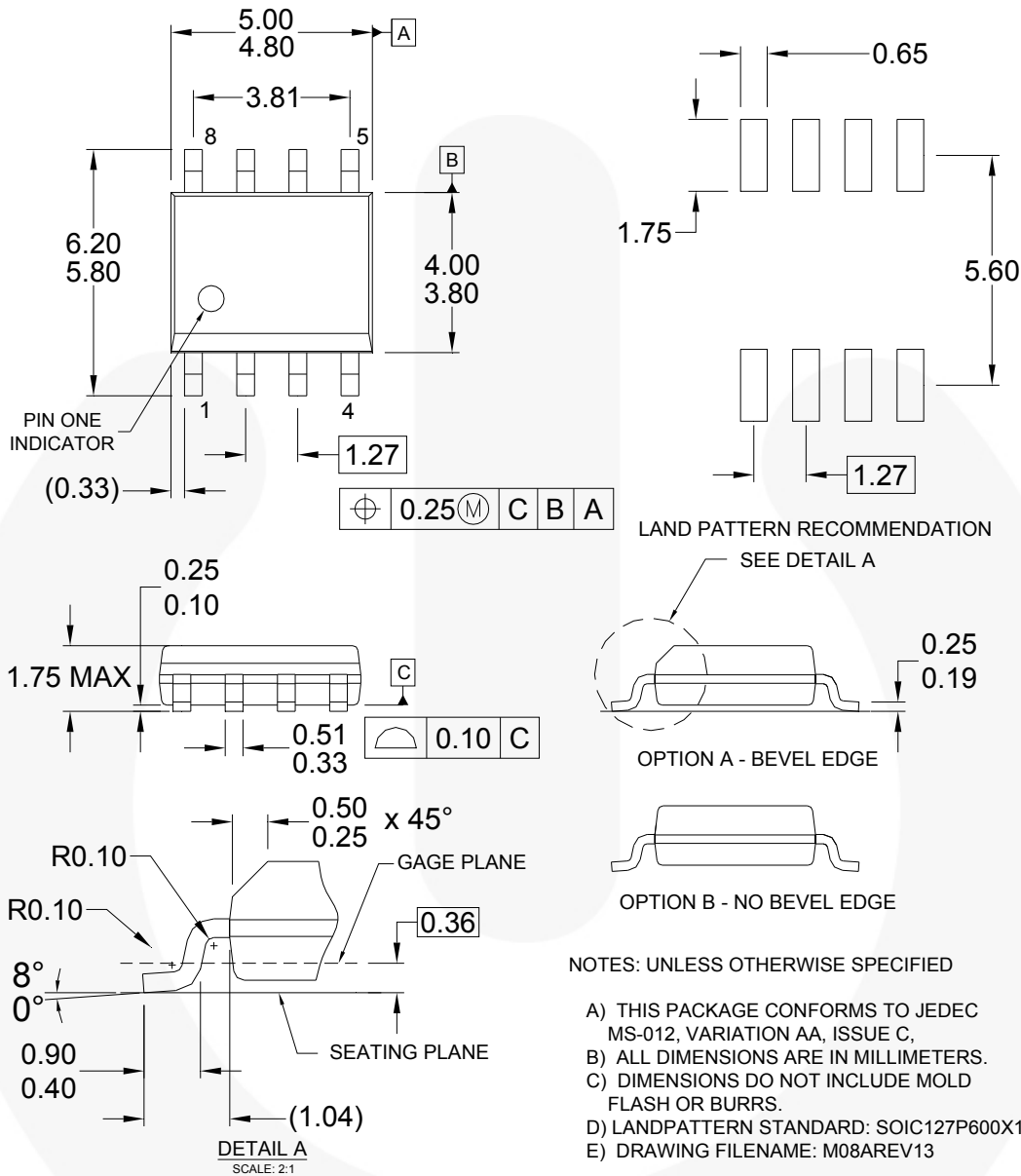

Figure 26. 8-Lead, Small-Outline Integrated Circuit (SOIC), JEDEC MS-012, .150-Inch Narrow Body

Package drawings are provided as a service to customers considering Fairchild components. Drawings may change in any manner without notice. Please note the revision and/or date on the drawing and contact a Fairchild Semiconductor representative to verify or obtain the most recent revision. Package specifications do not expand the terms of Fairchild's worldwide terms and conditions, specifically the warranty therein, which covers Fairchild products.

Always visit Fairchild Semiconductor's online packaging area for the most recent package drawings:
<http://www.fairchildsemi.com/packaging/>



TRADEMARKS

The following includes registered and unregistered trademarks and service marks, owned by Fairchild Semiconductor and/or its global subsidiaries, and is not intended to be an exhaustive list of all such trademarks.

- | | | | |
|---|--|---|---|
| 2Cool™ | F-PFS™ | PowerTrench® | The Power Franchise® |
| AccuPower™ | FRFET® | PowerXS™ |  |
| AX-CAP™* | Global Power Resource SM | Programmable Active Droop™ | TinyBoost™ |
| BitSiC™ | GreenBridge™ | QFET® | TinyBuck™ |
| Build it Now™ | Green FPS™ | QS™ | TinyCalc™ |
| CorePLUS™ | Green FPS™ e-Series™ | Quiet Series™ | TinyLogic® |
| CorePOWER™ | Gmax™ | RapidConfigure™ | TINYOPTO™ |
| CROSSVOLT™ | GTO™ |  | TinyPower™ |
| CTL™ | IntelliMAX™ | Saving our world, 1mW/W/kW at a time™ | TinyPWM™ |
| Current Transfer Logic™ | ISOPLANAR™ | SignalWise™ | TinyWire™ |
| DEUXPEED® | Making Small Speakers Sound Louder and Better™ | SmartMax™ | TranSiC™ |
| Dual Cool™ | MegaBuck™ | SMART START™ | TriFault Detect™ |
| EcoSPARK® | MICROCOUPLER™ | Solutions for Your Success™ | TRUECURRENT®* |
| EfficientMax™ | MicroFET™ | SPM® | μSerDes™ |
| ESBC™ | MicroPak™ | STEALTH™ |  |
|  | MicroPak2™ | SuperFET® | UHC® |
| Fairchild® | MillerDrive™ | SuperSOT™-3 | Ultra FRFET™ |
| Fairchild Semiconductor® | MotionMax™ | SuperSOT™-6 | UniFET™ |
| FACT Quiet Series™ | Motion-SPM™ | SuperSOT™-8 | VCX™ |
| FACT® | mWSaver™ | SupreMOS® | VisualMax™ |
| FAST® | OptoHIT™ | SyncFET™ | VoltagePlus™ |
| FastvCore™ | OPTOLOGIC® | Sync-Lock™ | XS™ |
| FETBench™ | OPTOPLANAR® |  | |
| FlashWriter®* | | | |
| FPS™ | | | |

* Trademarks of System General Corporation, used under license by Fairchild Semiconductor.

DISCLAIMER

FAIRCHILD SEMICONDUCTOR RESERVES THE RIGHT TO MAKE CHANGES WITHOUT FURTHER NOTICE TO ANY PRODUCTS HEREIN TO IMPROVE RELIABILITY, FUNCTION, OR DESIGN. FAIRCHILD DOES NOT ASSUME ANY LIABILITY ARISING OUT OF THE APPLICATION OR USE OF ANY PRODUCT OR CIRCUIT DESCRIBED HEREIN; NEITHER DOES IT CONVEY ANY LICENSE UNDER ITS PATENT RIGHTS, NOR THE RIGHTS OF OTHERS. THESE SPECIFICATIONS DO NOT EXPAND THE TERMS OF FAIRCHILD'S WORLDWIDE TERMS AND CONDITIONS, SPECIFICALLY THE WARRANTY THEREIN, WHICH COVERS THESE PRODUCTS.

LIFE SUPPORT POLICY

FAIRCHILD'S PRODUCTS ARE NOT AUTHORIZED FOR USE AS CRITICAL COMPONENTS IN LIFE SUPPORT DEVICES OR SYSTEMS WITHOUT THE EXPRESS WRITTEN APPROVAL OF FAIRCHILD SEMICONDUCTOR CORPORATION.

As used herein:

1. Life support devices or systems are devices or systems which, (a) are intended for surgical implant into the body or (b) support or sustain life, and (c) whose failure to perform when properly used in accordance with instructions for use provided in the labeling, can be reasonably expected to result in a significant injury of the user.
2. A critical component in any component of a life support, device, or system whose failure to perform can be reasonably expected to cause the failure of the life support device or system, or to affect its safety or effectiveness.

ANTI-COUNTERFEITING POLICY

Fairchild Semiconductor Corporation's Anti-Counterfeiting Policy. Fairchild's Anti-Counterfeiting Policy is also stated on our external website, www.fairchildsemi.com, under Sales Support.

Counterfeiting of semiconductor parts is a growing problem in the industry. All manufacturers of semiconductor products are experiencing counterfeiting of their parts. Customers who inadvertently purchase counterfeit parts experience many problems such as loss of brand reputation, substandard performance, failed applications, and increased cost of production and manufacturing delays. Fairchild is taking strong measures to protect ourselves and our customers from the proliferation of counterfeit parts. Fairchild strongly encourages customers to purchase Fairchild parts either directly from Fairchild or from Authorized Fairchild Distributors who are listed by country on our web page cited above. Products customers buy either from Fairchild directly or from Authorized Fairchild Distributors are genuine parts, have full traceability, meet Fairchild's quality standards for handling and storage and provide access to Fairchild's full range of up-to-date technical and product information. Fairchild and our Authorized Distributors will stand behind all warranties and will appropriately address any warranty issues that may arise. Fairchild will not provide any warranty coverage or other assistance for parts bought from Unauthorized Sources. Fairchild is committed to combat this global problem and encourage our customers to do their part in stopping this practice by buying direct or from authorized distributors.

PRODUCT STATUS DEFINITIONS

Definition of Terms

Datasheet Identification	Product Status	Definition
Advance Information	Formative / In Design	Datasheet contains the design specifications for product development. Specifications may change in any manner without notice.
Preliminary	First Production	Datasheet contains preliminary data; supplementary data will be published at a later date. Fairchild Semiconductor reserves the right to make changes at any time without notice to improve design.
No Identification Needed	Full Production	Datasheet contains final specifications. Fairchild Semiconductor reserves the right to make changes at any time without notice to improve the design.
Obsolete	Not In Production	Datasheet contains specifications on a product that is discontinued by Fairchild Semiconductor. The datasheet is for reference information only.

Rev. 161