

# 4 x 3.5 mm MOSFET BGA Package Dimensions

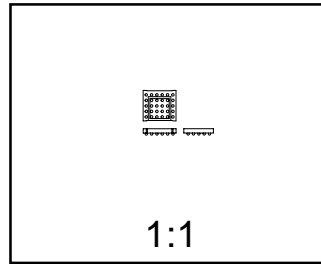

## 4 x 3.5 mm

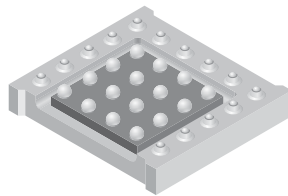

1:1

Scale 1:1 on letter size paper

Dimensions shown below are in:  
millimeters

Part Weight per unit (gram): 0.0824

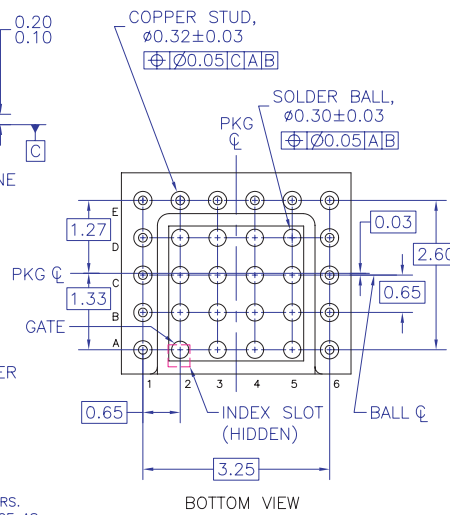
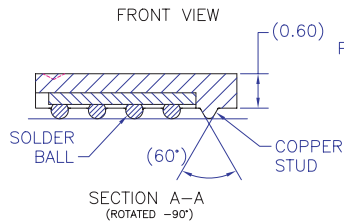
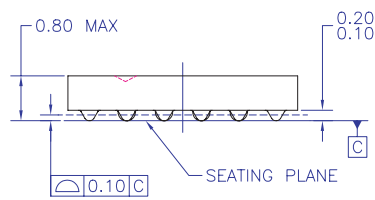
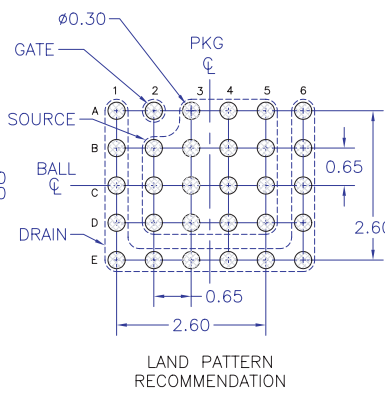
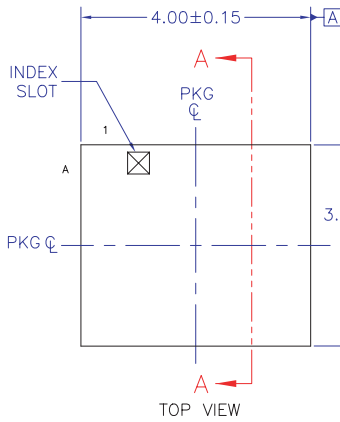

- NOTES: UNLESS OTHERWISE SPECIFIED  
 A) ALL DIMENSIONS ARE IN MILLIMETERS.  
 B) NO JEDEC REGISTRATION REFERENCE AS OF JULY 1999.  
 C) TERMINAL CONFIGURATION TABLE

POSITION	DESIGNATION	TYPE
A1, B1, C1, D1, E1, E2, E3, E4, E5, E6, D6, C6, B6, A6	DRAIN	COPPER STUD
A2	GATE	SOLDER BALL
A3, A4, A5, B2, B3, B4, B5, C2, C3, C4, C5, D2, D3, D4, D5	SOURCE	SOLDER BALL