

# SuperSOT™ -3

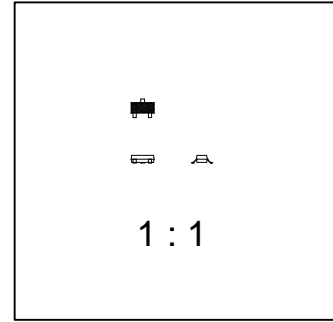

Scale 1:1 on letter size paper

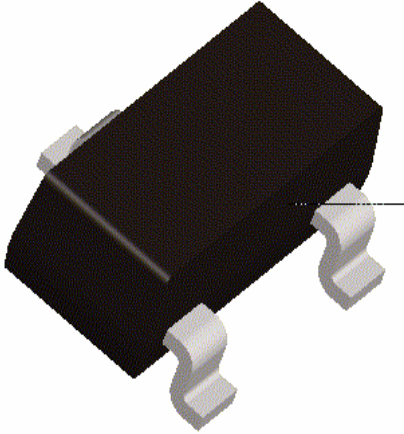
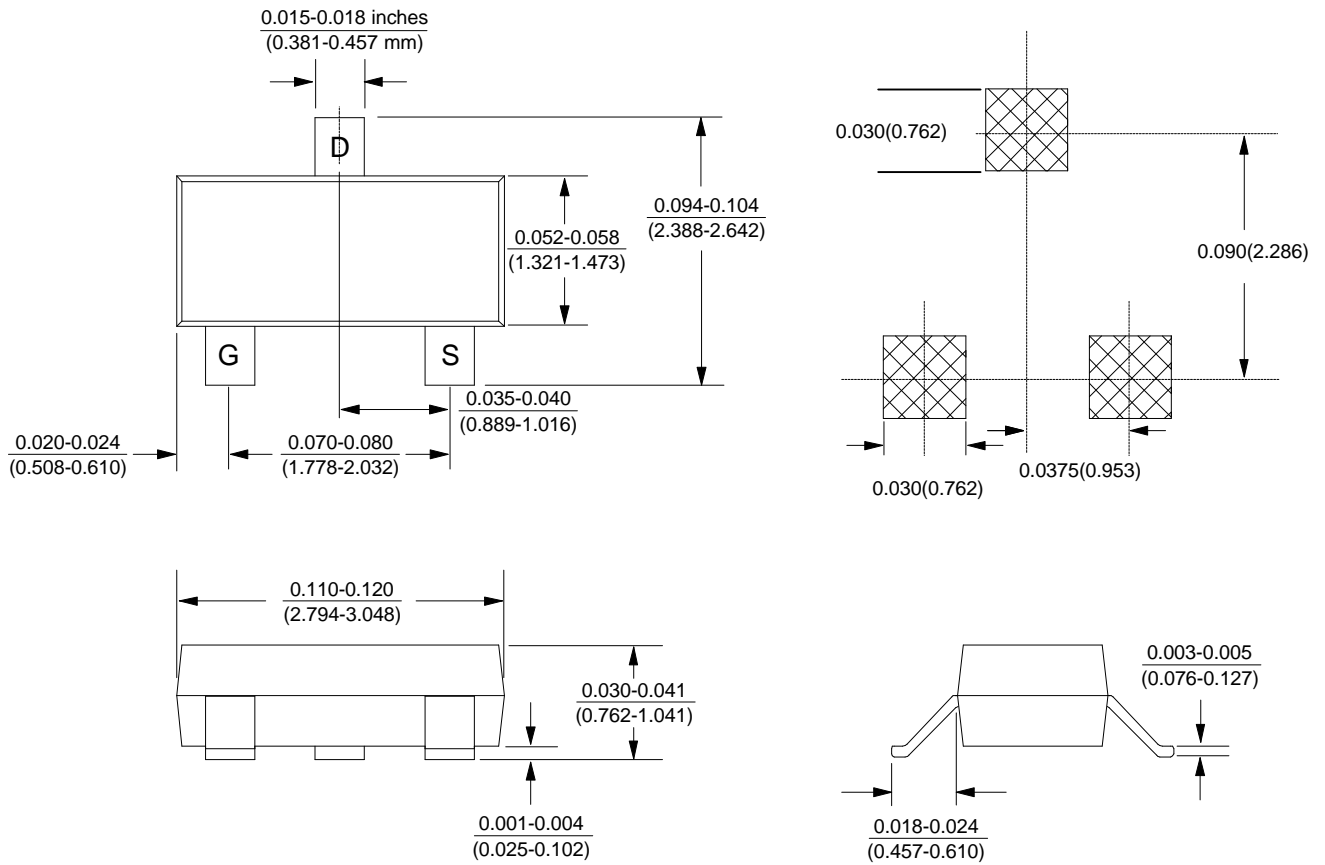

# SuperSOT™ -6

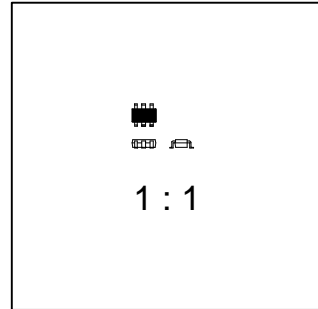
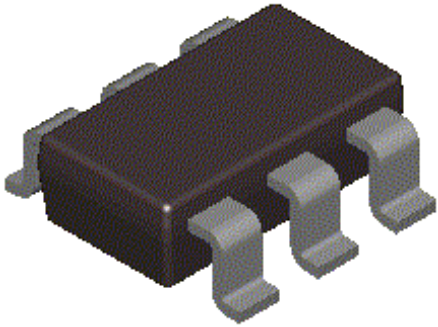

Scale 1:1 on letter size paper

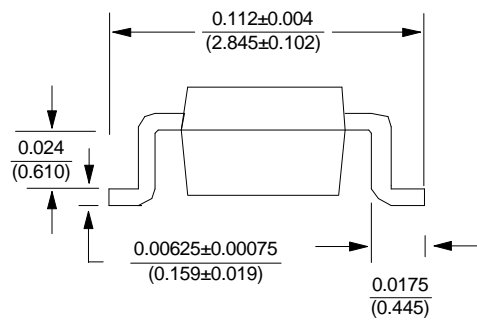
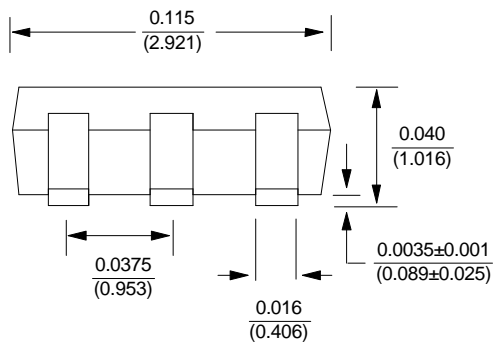
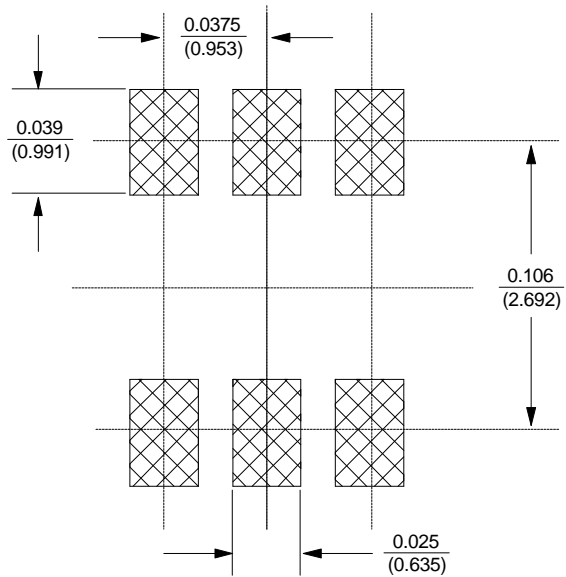
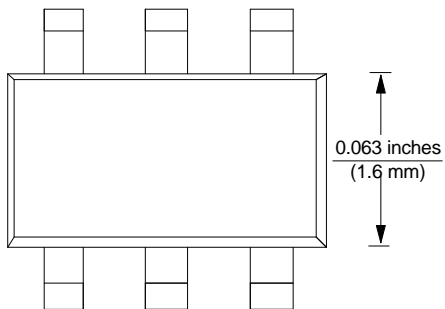

# SuperSOT™-8

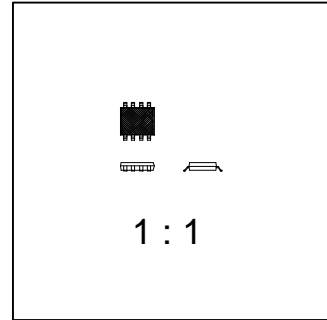
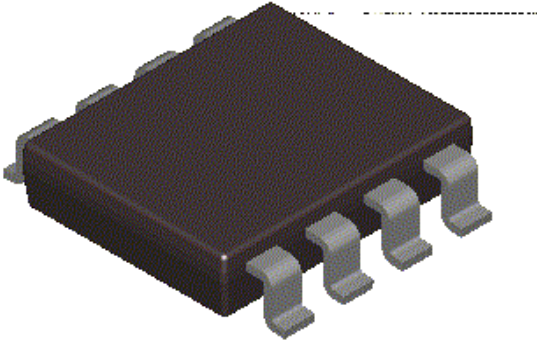

Scale 1:1 on letter size paper

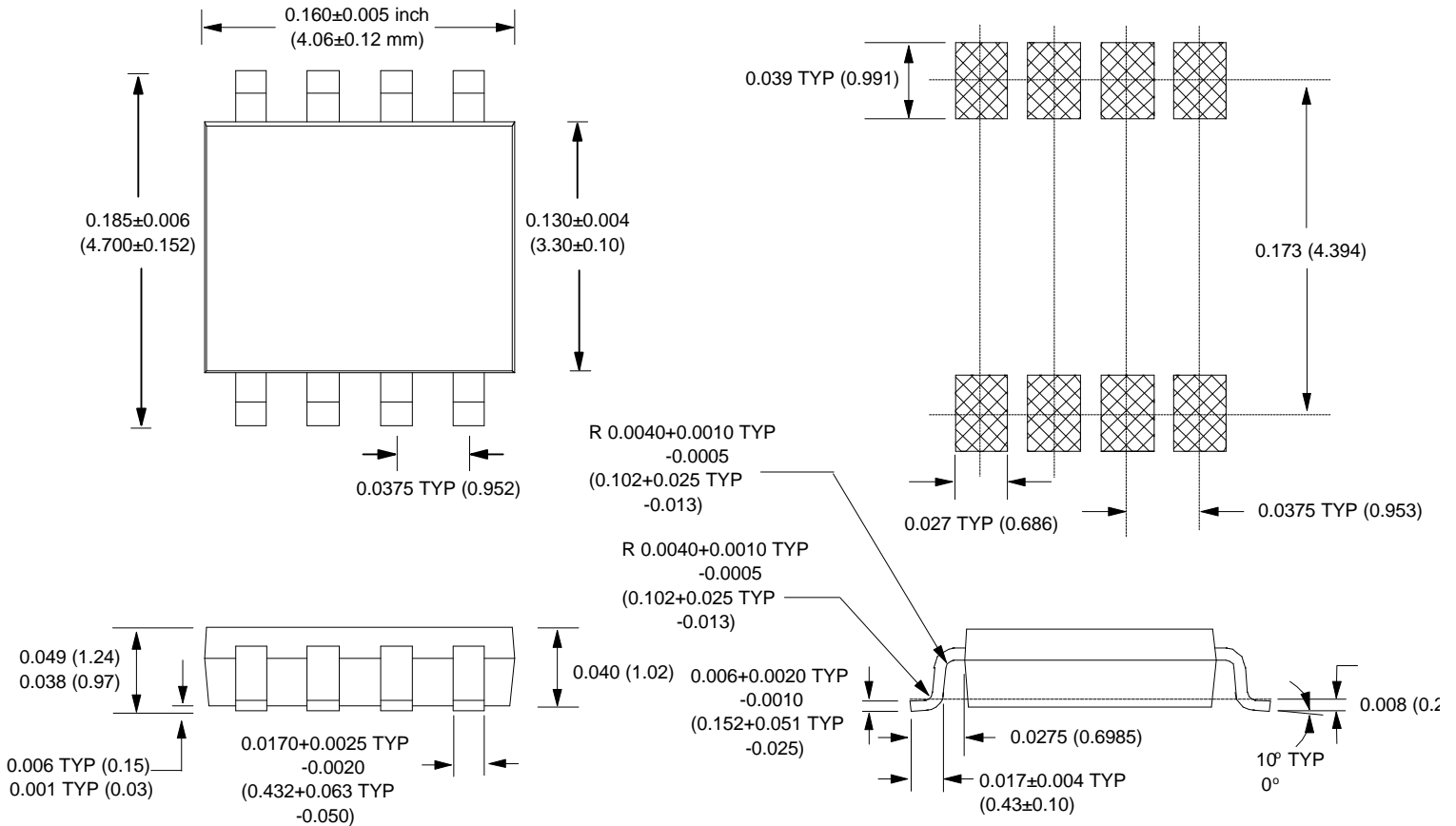

# SO-8

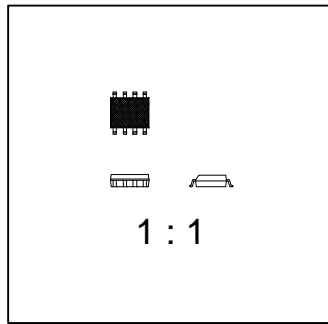
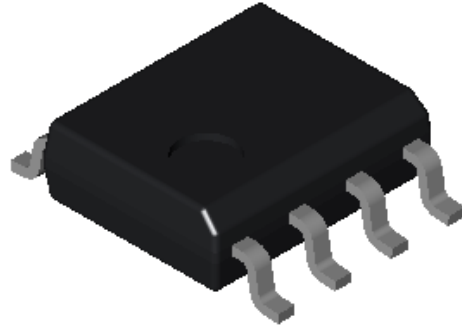

Scale 1:1 on letter size paper

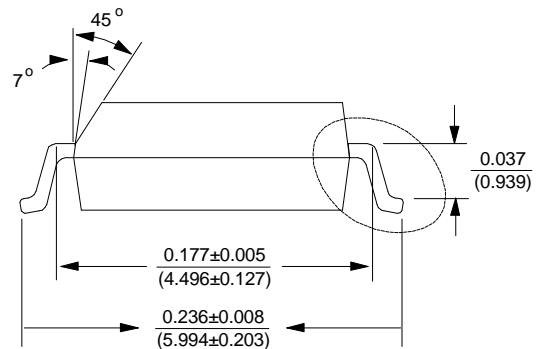
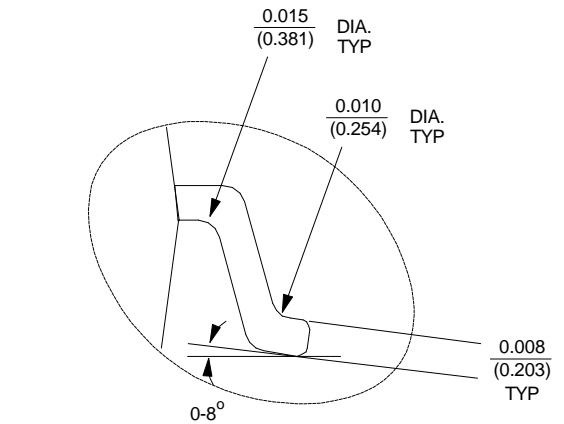
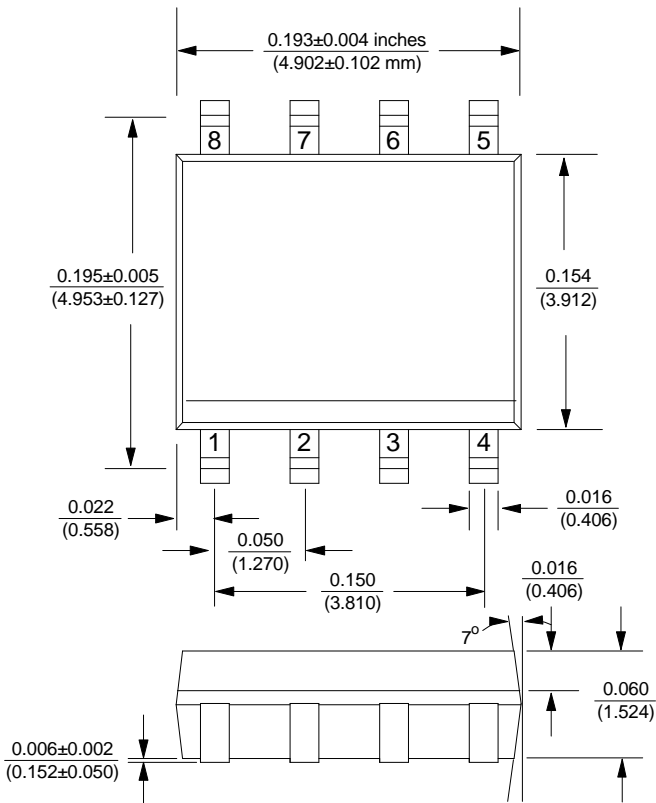
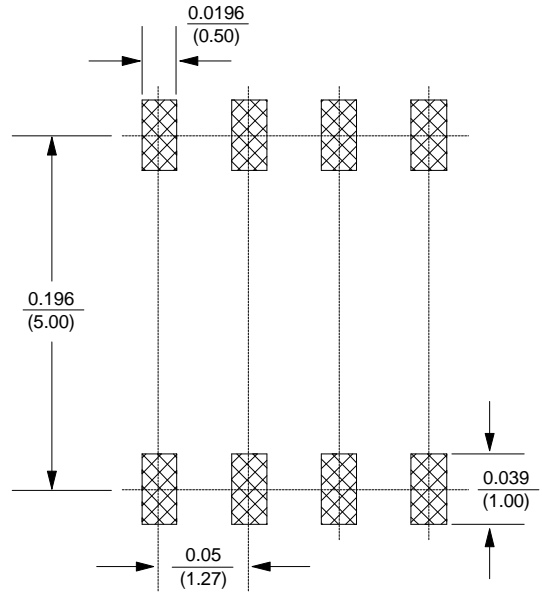

# SOT-223

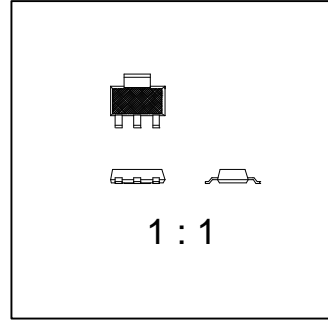
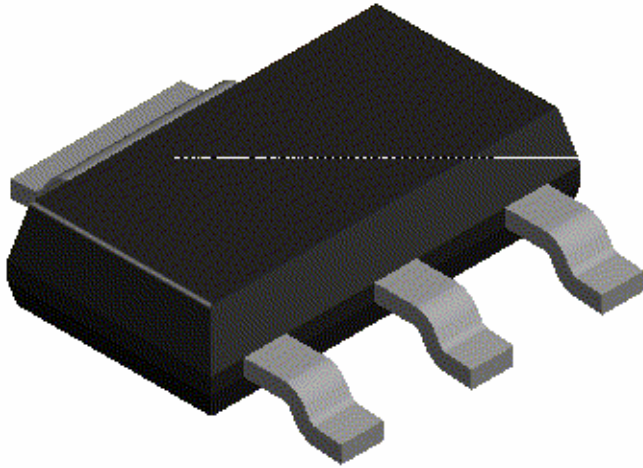

Scale 1:1 on letter size paper

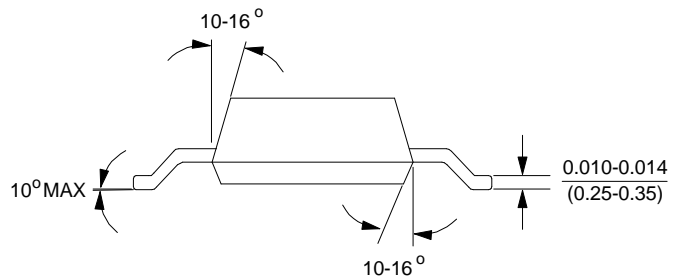
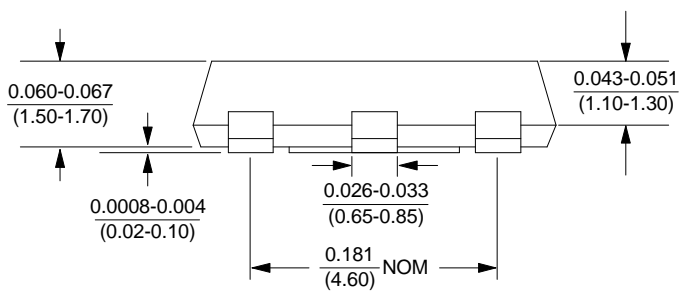
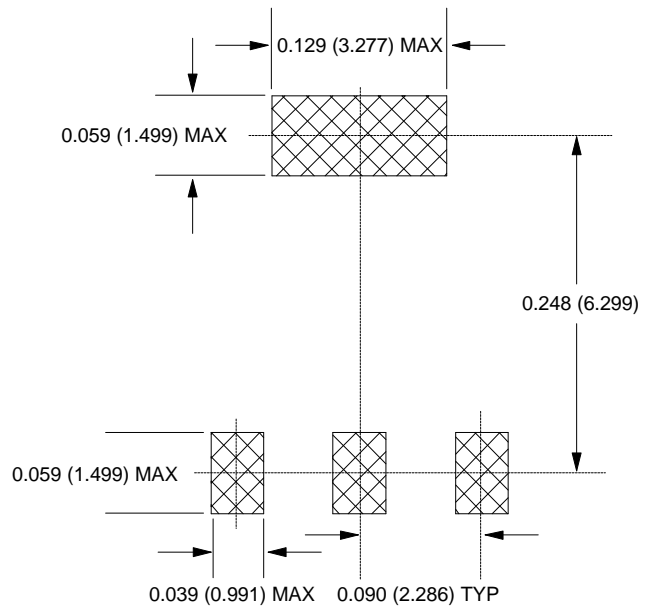
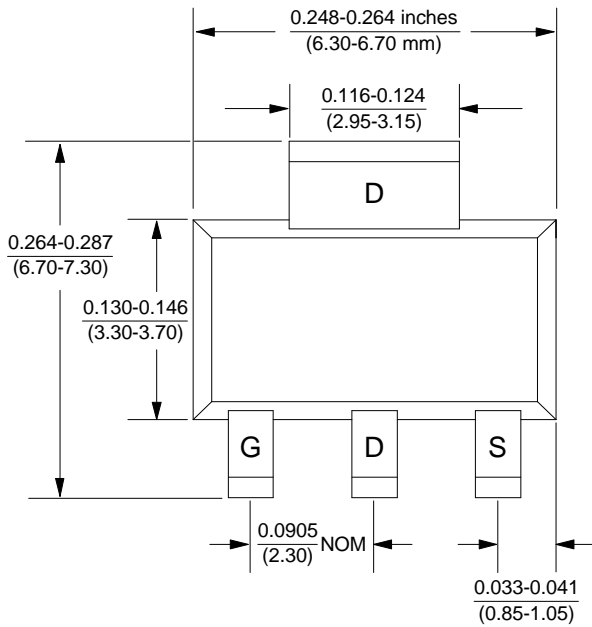

# SOT-23

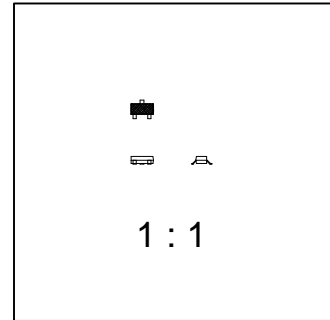
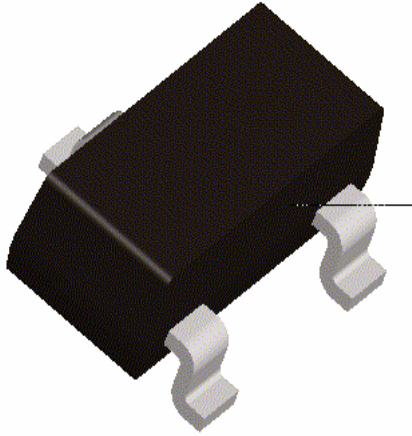

Scale 1:1 on letter size paper

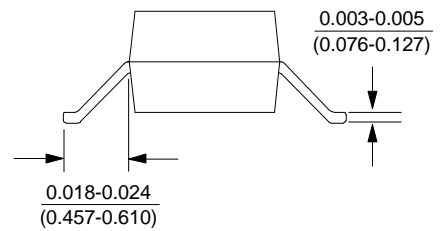
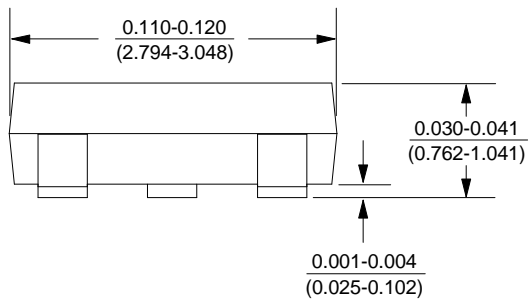
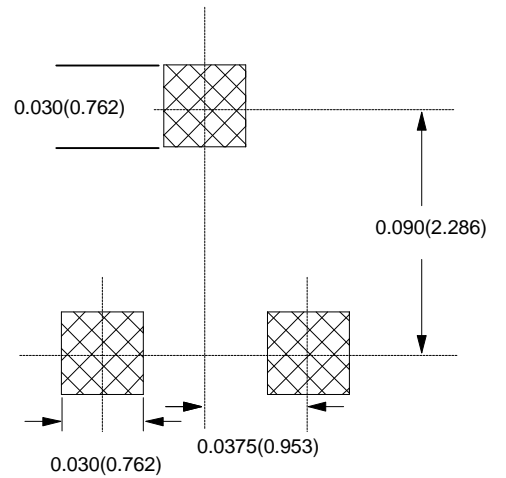
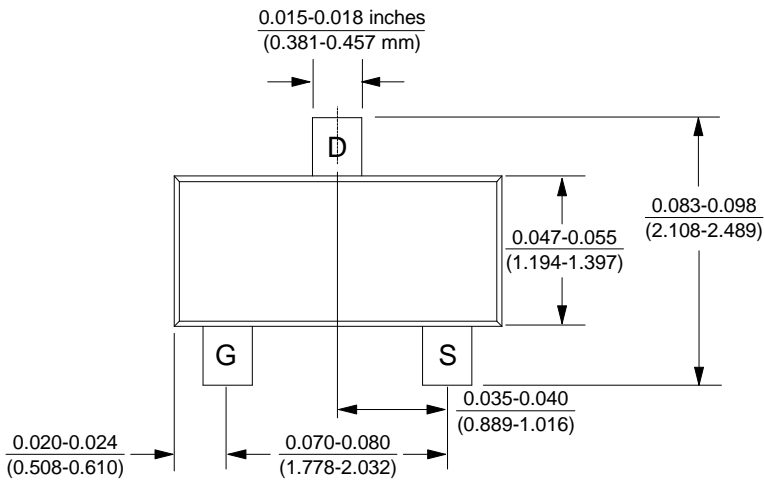

**TO-92** (PKG CODE 92)

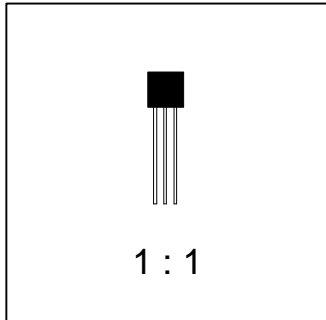

1 : 1

Scale 1:1 on letter size paper

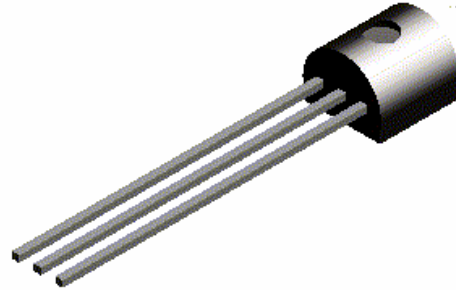

D  
G  
S

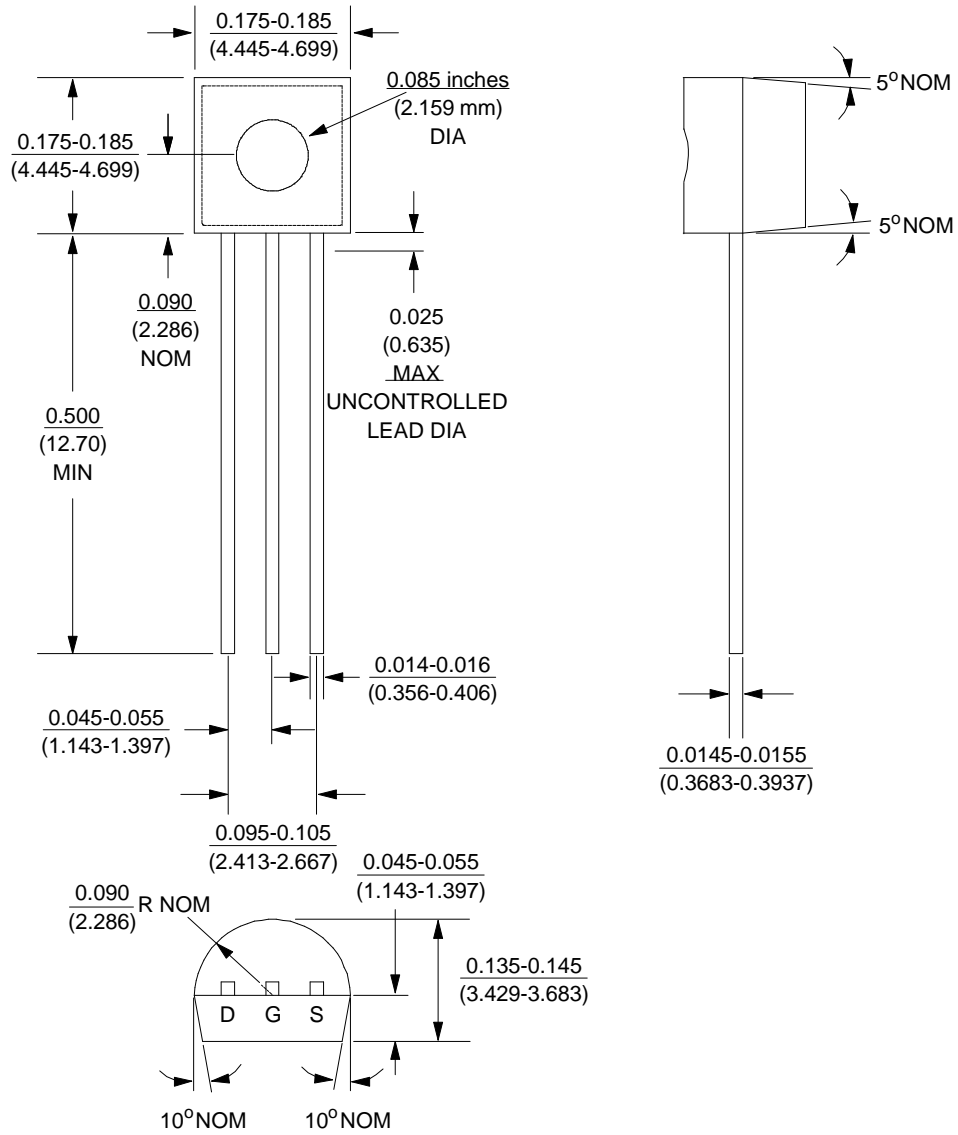

**TO-92** (PKG CODE 97)

**TO-18 Lead Form STD**

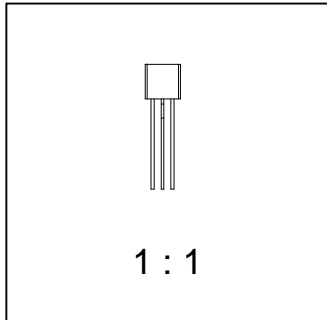

Scale 1:1 on letter size paper

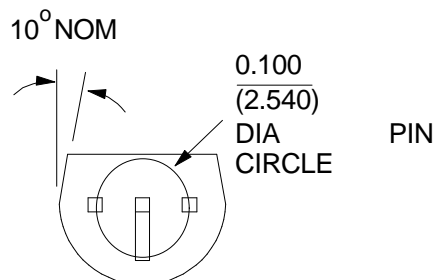
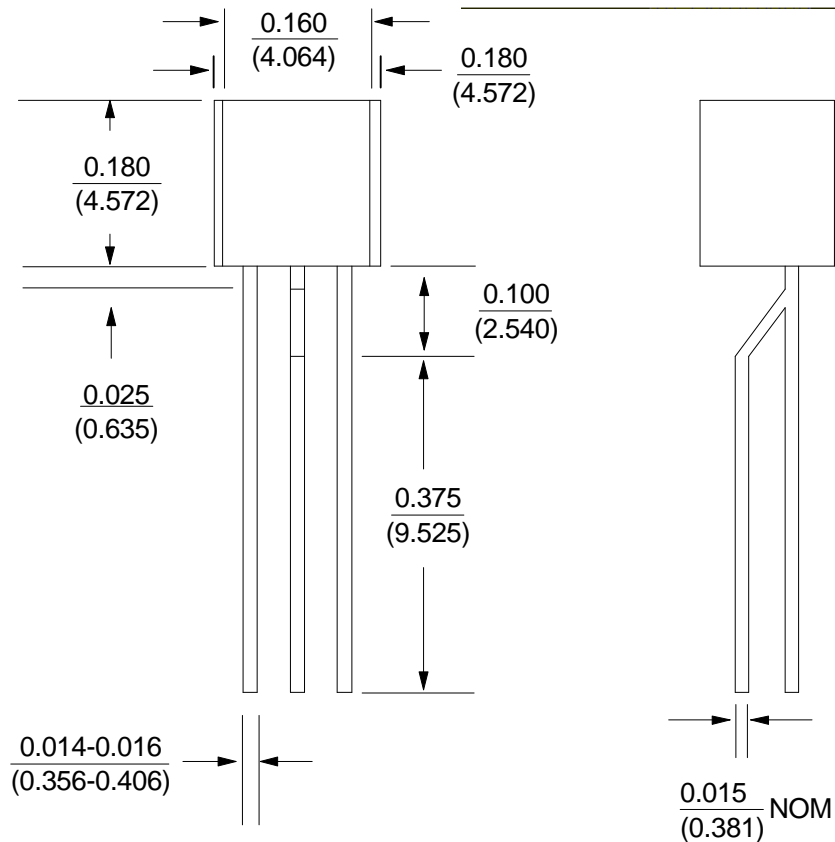
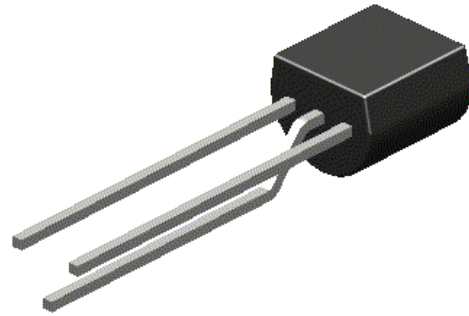

**TO-220** (PKG CODE 37)

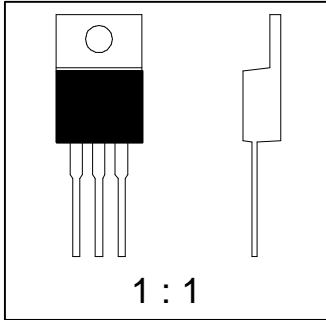

Scale 1:1 on letter size paper

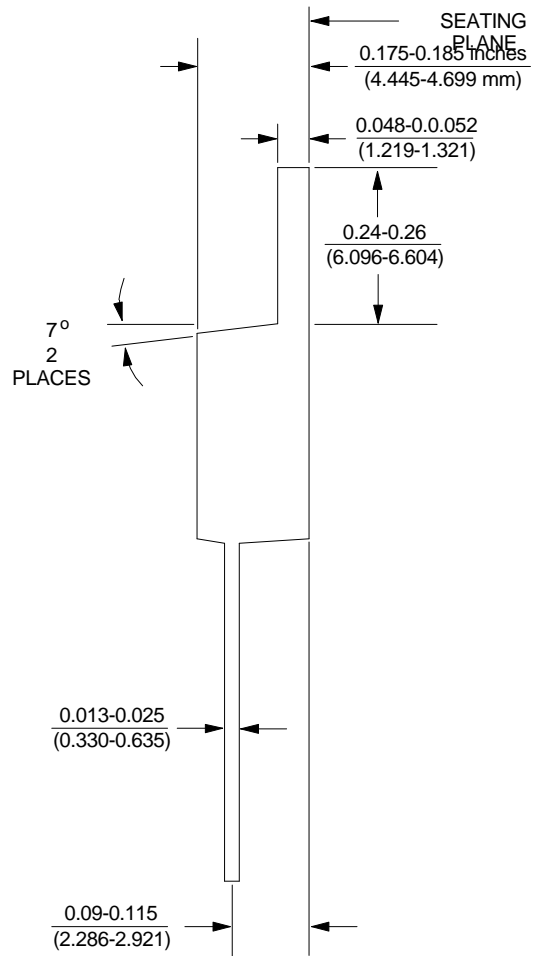
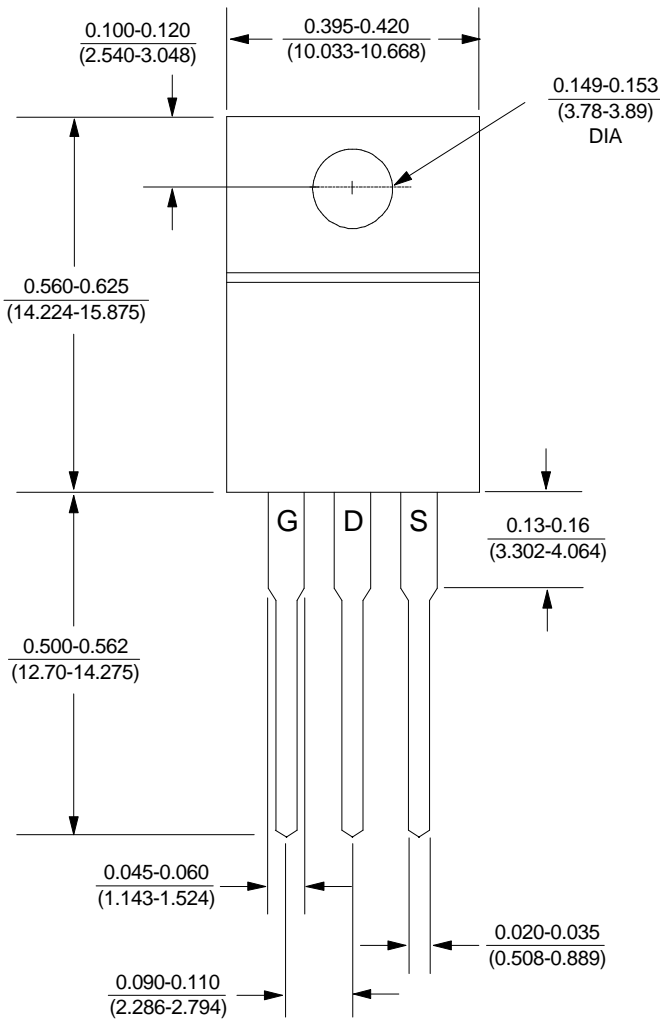
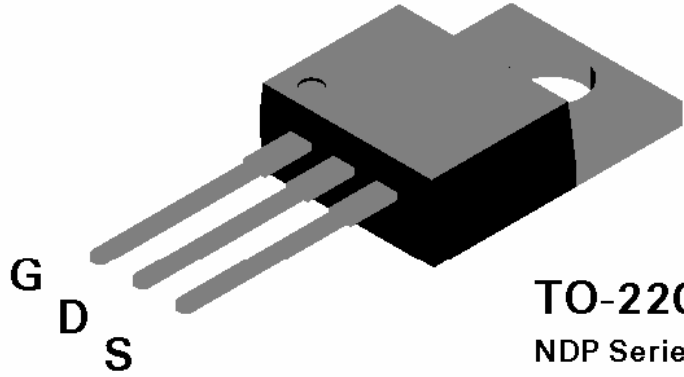

# TO-263AB

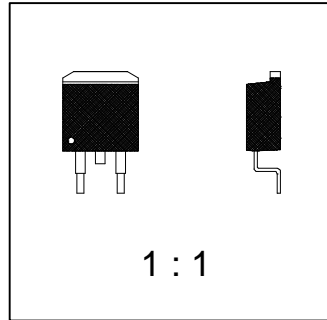
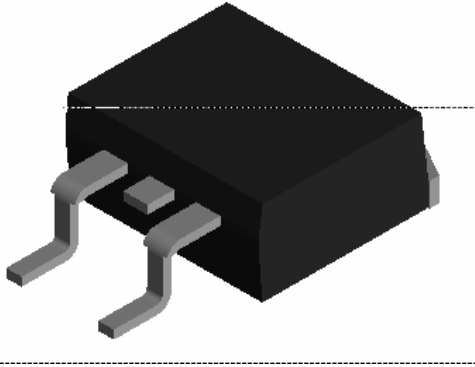

Scale 1:1 on letter size paper

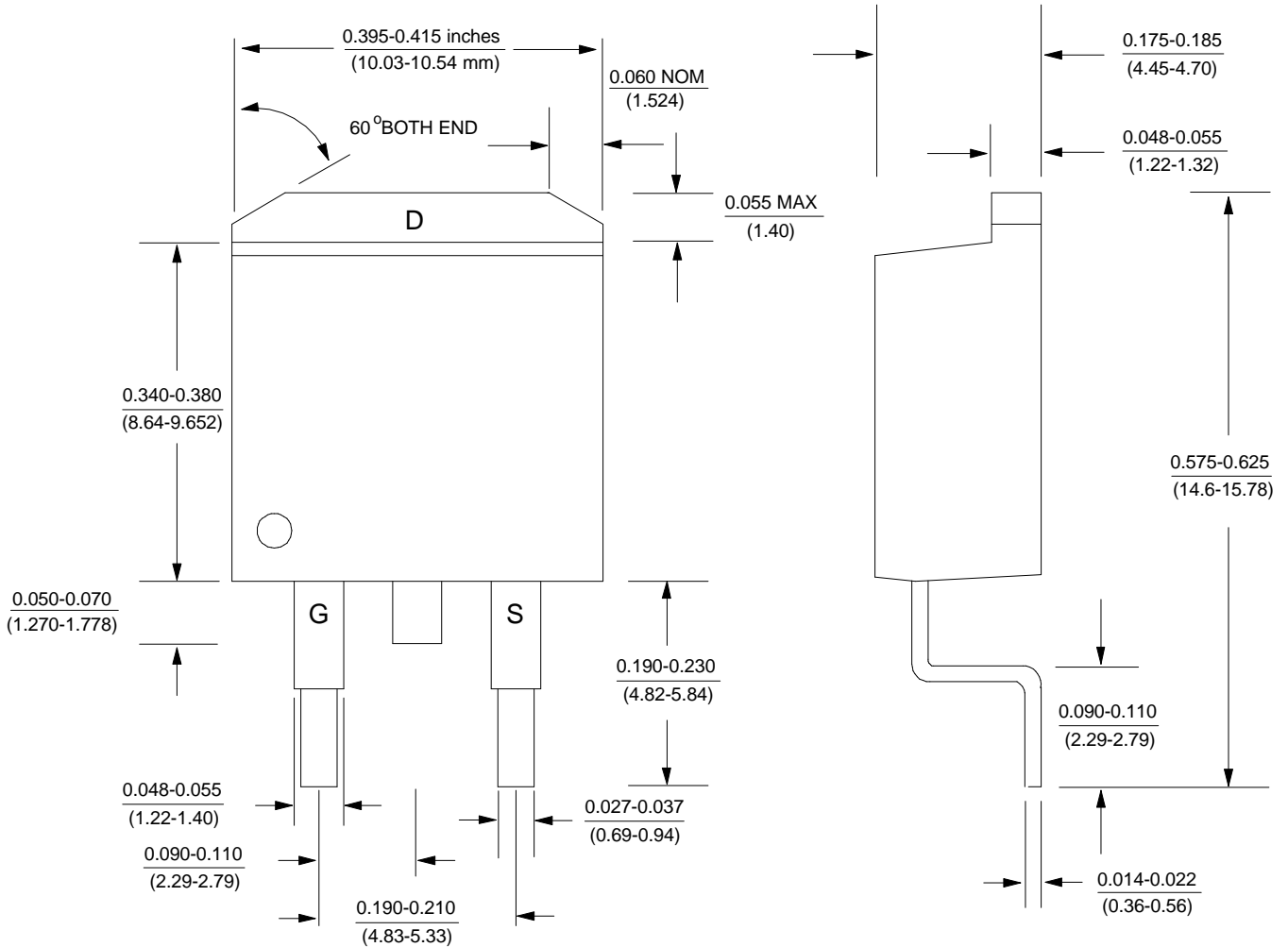
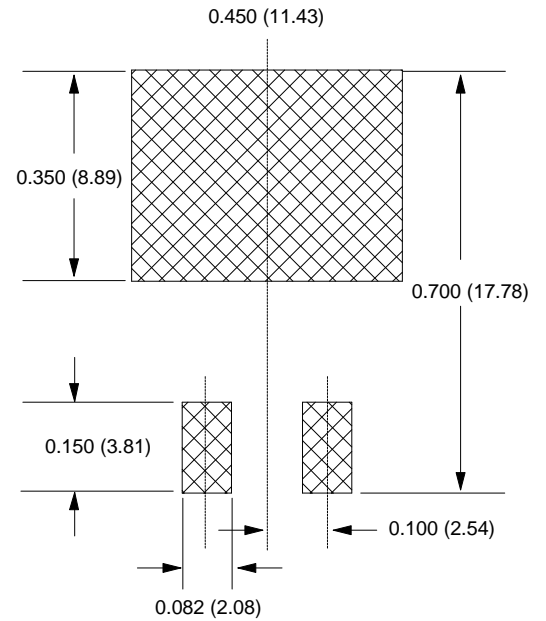

# SOIC-16

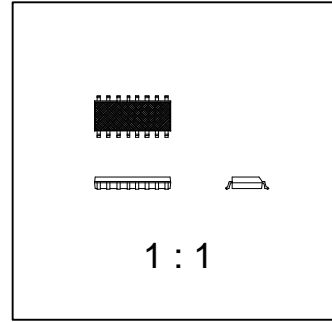
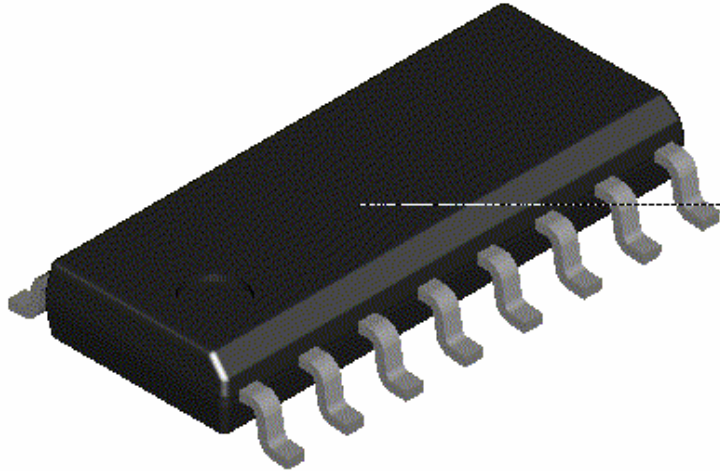

Scale 1:1 on letter size paper

