

THIS DRAWING IS THE PROPERTY OF FAIRCHILD SEMICONDUCTOR CORPORATION. NO USE THEREOF SHALL BE MADE OTHER THAN AS A REFERENCE FOR PROPOSALS AS SUBMITTED TO FAIRCHILD SEMICONDUCTOR CORPORATION FOR JOBS TO BE EXECUTED IN CONFORMITY WITH SUCH PROPOSALS UNLESS THE CONSENT OF SAID FAIRCHILD SEMICONDUCTOR CORPORATION HAS PREVIOUSLY BEEN OBTAINED. NO PART OF THIS DRAWING SHALL BE COPIED OR DUPLICATED OR ITS CONTENTS DISCLOSED. THE INFORMATION CONTAINED ON THIS DRAWING IS CONFIDENTIAL AND PROPRIETARY.

REVISIONS				
REV	DESCRIPTION	ECN	DATE	NAME/SITE
1	RELEASE TO DOCUMENT CONTROL	CB/E35/10	04/JUN/10	FSCP

PQFN 5x6 Single and Dual Asymmetric (Dual Dap) Packaging Configuration: Figure 1.0

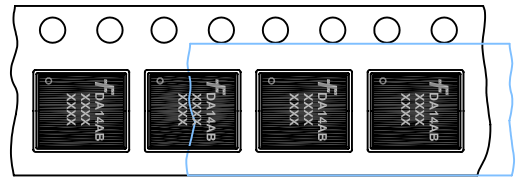
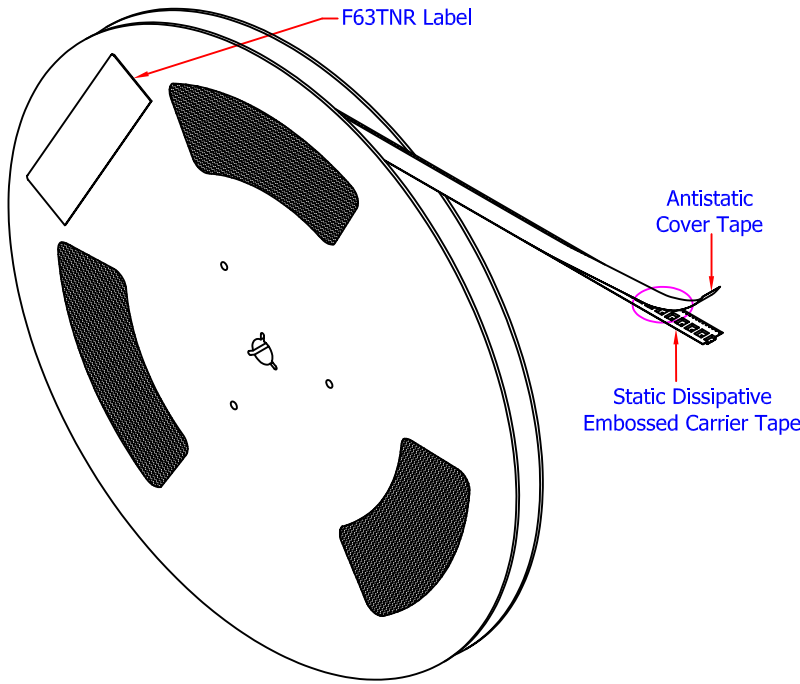

PQFN 5x6 Single and Dual Asymmetric (Dual Dap) Unit Orientation

Packaging Description:

PQFN 5x6 Single and Dual Asymmetric (Dual Dap) parts are shipped in tape. The carrier tape is made from a conductive / dissipative (carbon filled) polycarbonate resin or polystyrene. The cover tape is a multilayer film HAA (Heat Activated Adhesive in nature) primarily composed of polyester film, adhesive layer, sealant, and anti-static sprayed agent. These reeled parts in standard option are shipped with 3,000 units per 13" or 330mm diameter reel. The reels are dark blue or black in color and is made of polystyrene plastic (anti-static coated).

These full reels are individually barcode labeled, and placed inside a standard box (illustrated in figure 1.0) made of recyclable corrugated brown paper. One pizza box contains two reels maximum. And these boxes are placed inside a barcode labeled shipping box which comes in different sizes depending on the number of parts shipped.

PQFN 5x6 Single and Dual Asymmetric (Dual Dap) Packaging information	
Packaging Option	Standard (no flow code)
Packaging type	TNR
Qty per Reel/Tube/Bag	3000
Reel Size	13" Dia
Box Dimension (mm)	INTR0004
Max qty per Box	6,000
Weight per unit (gm)	0.0911
Weight per reel (kg)	0.6310
Note/Comments	

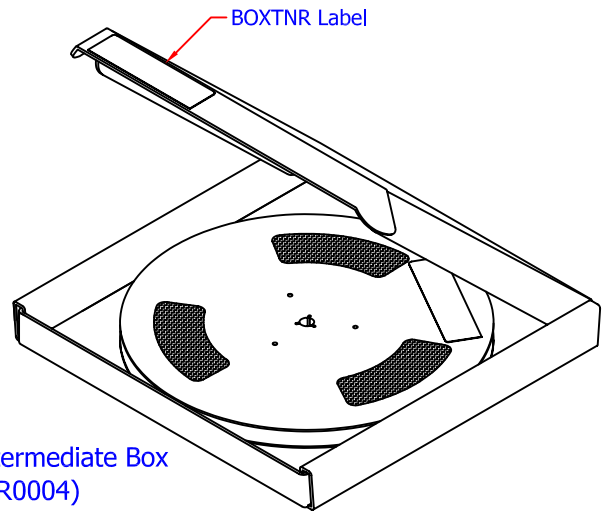

Standard Intermediate Box (INTR0004)

Barcode Label Sample

LOT: DC10324746 QTY: 3000
 FSID: XXXXXXXXXXXX SPEC:
 D/C1: D1015AC QTY1: SPEC REV: 2nd Level Interconnect
 D/C2: QTY2: Green Component 1. Category G4
 RoHS COMPLIANT 2. Maximum safe temperature 260 deg C
 FAIRCHILD SEMICONDUCTOR (F63TNR) 6,1

PQFN 5x6 Single and Dual Asymmetric (Dual Dap) Tape Leader and Trailer Configuration: Figure 2.0

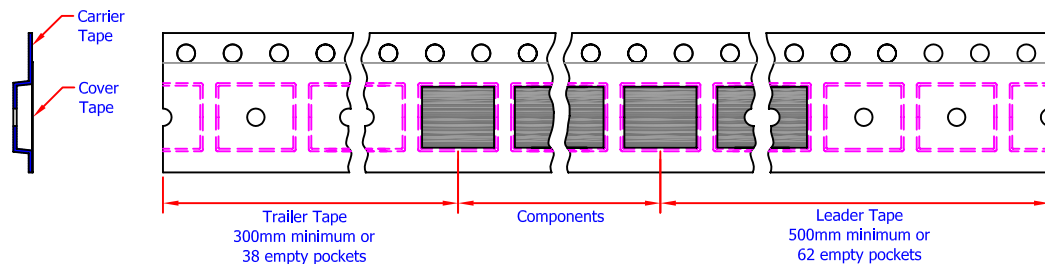

APPROVALS	DATE	
DRAWN: G. I. GEQUILLO	05APRIL'10	
CHECKED: L. B. PATIÑO		
APPROVED: M. R. GESTOLE		
J. A. ORTEGA		PQFN 5x6 SINGLE AND DUAL ASYMMETRIC(DUAL DAP) PACKAGING CONFIGURATION
		SCALE: 1:1 SIZE: (CB)50-0023 FORMERLY: N/A
		SHEET: 1 OF 2

REVISIONS				
REV	DESCRIPTION	ECN	DATE	NAME/SITE
1	RELEASE TO DOCUMENT CONTROL	CB/635/10	04/JUN/10	FSCP

PQFN 5x6 Single and Dual Asymmetric (Dual Dap) Embossed Carrier Tape Configuration: Figure 3.0

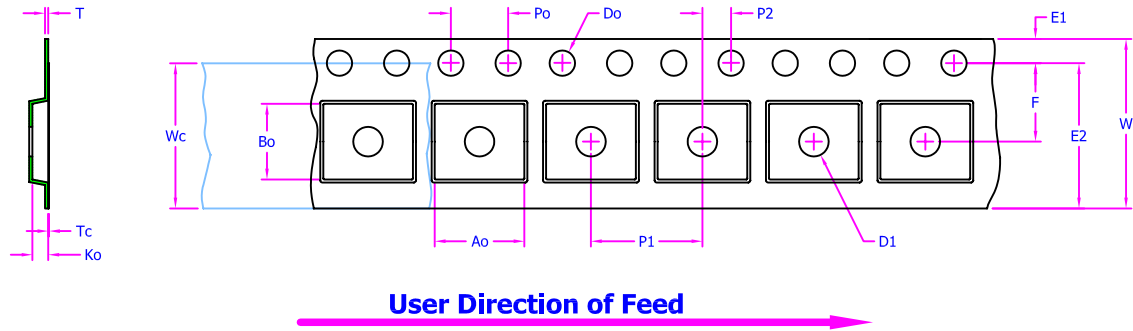

Dimensions are in millimeters

Pkg type	Ao	Bo	W	Do	D1	E1	E2	F	P1	P2	Po	Ko	T	Wc	Tc
5x6 PQFN (12mm)	6.35 ±0.10	5.35 ±0.10	12.0 +0.20 -0.1	1.50 +0.10 -0	1.50 +0.25 -0	1.75 ±0.10	10.25 Min	5.50 ±0.05	8.0 ±0.10	2.0 ±0.05	4.00 ±0.10	1.30 ±0.10	0.30 ±0.03	9.20 ±0.10	0.06 ±0.02

Notes: Ao, Bo, and Ko dimensions are determined with respect to the EIA/Jedec RS-481 rotational and lateral movement requirements (see sketches A, B, and C).

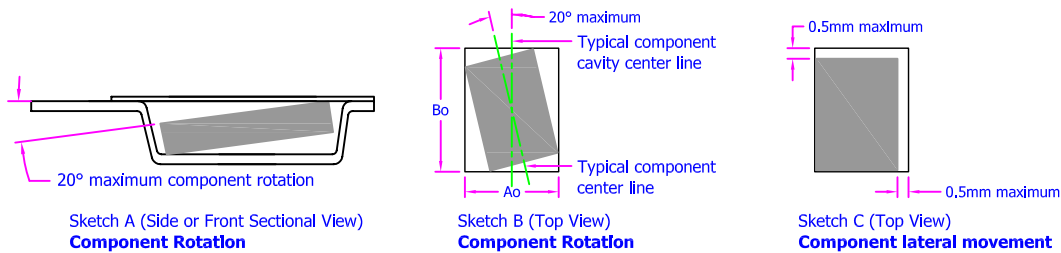

PQFN 5x6 Single and Dual Asymmetric (Dual Dap) Reel Configuration: Figure 4.0

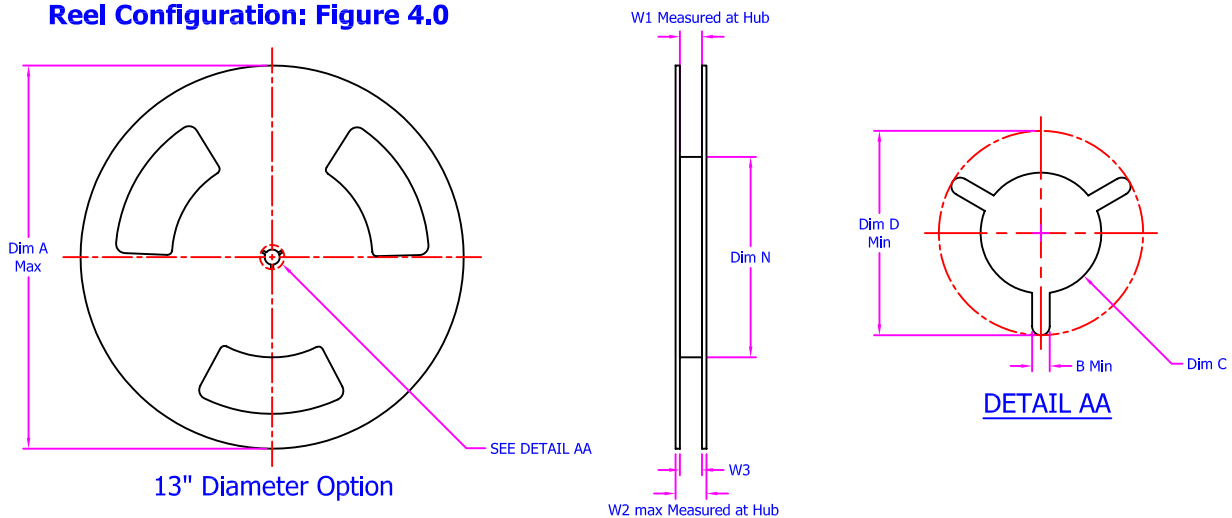

Dimensions are in inches and millimeters

Tape Size	Reel Option	Dim A	Dim B	Dim C	Dim D	Dim N	Dim W1	Dim W2	Dim W3 (LSL-USL)
12mm	13" Dia	330	1.5	13+0.5/-0.2	20.2	178	12.4+2/-0	18.4	11.9-15.4

- NOTE:
- Plastic reel W1 dimension control limit of;
 - 8mm reel = ±1.0mm
 - 12mm reel and above = ±1.5mm

APPROVALS	DATE									
DRAWN: G. I. GEQUILLO	05APR'10									
CHECKED: L. B. PATIÑO										
APPROVED: M. R. GESTOLE										
J. A. ORTEGA		<p style="text-align: center;">PQFN 5x6 SINGLE & DUAL EMBOSSED CARRIER TAPE AND REEL CONFIGURATION</p>								
		<table border="1"> <tr> <td>SCALE</td> <td>SIZE</td> <td>DRAWING NUMBER</td> <td>REV</td> </tr> <tr> <td>1:1</td> <td></td> <td>(CB)50-0023</td> <td>1</td> </tr> </table>	SCALE	SIZE	DRAWING NUMBER	REV	1:1		(CB)50-0023	1
SCALE	SIZE	DRAWING NUMBER	REV							
1:1		(CB)50-0023	1							
FORMERLY: N/A		SHEET: 2 OF 2								