

# PCB Layouts

## 4-Pin Half-Pitch Mini-Flat Package (White)

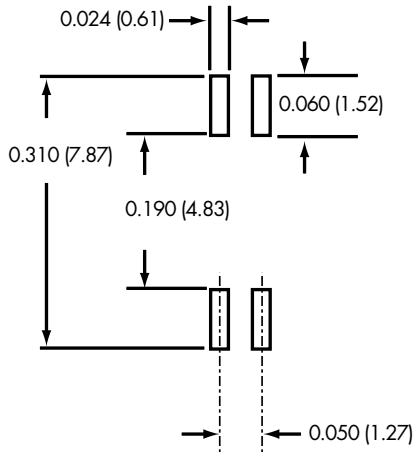

## 4-Pin Full-Pitch Mini-Flat Package (White)

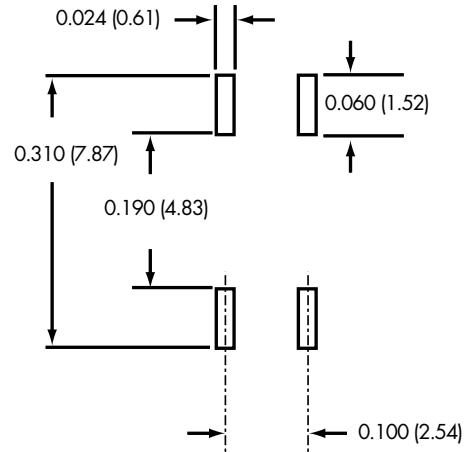

## 4-Pin Surface Mount Dual In-line Package (Black)

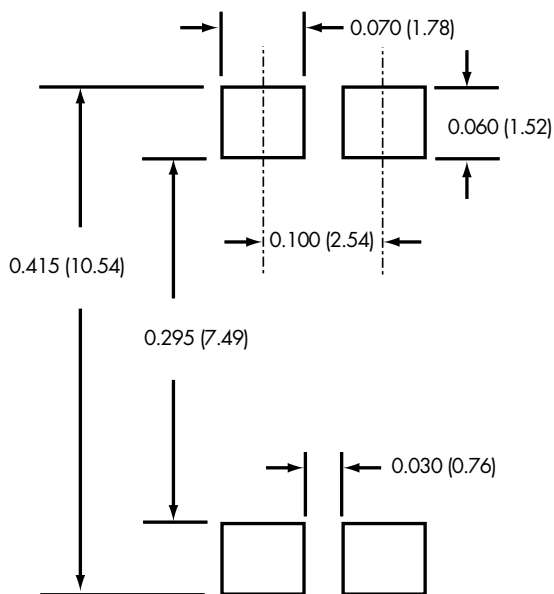

All dimensions are in inches (millimeters)

# PCB Layouts

## 6-Pin Surface Mount Dual In-line Package (White)

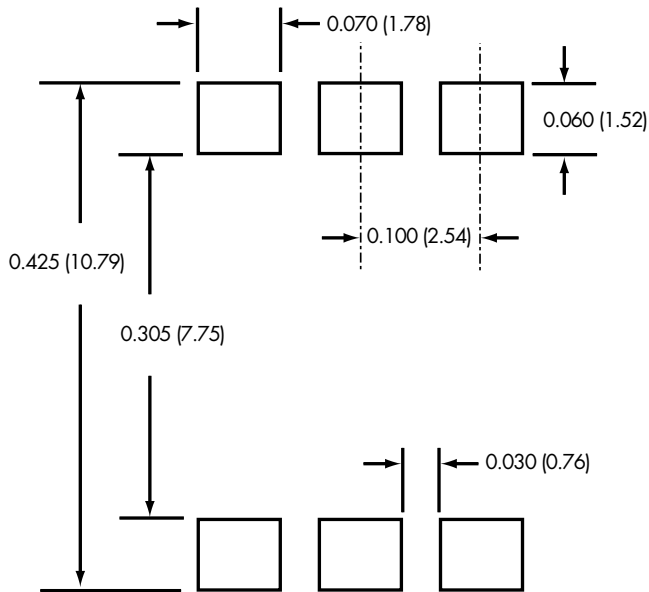

## 8-Pin Surface Mount Dual In-line Package (Black)

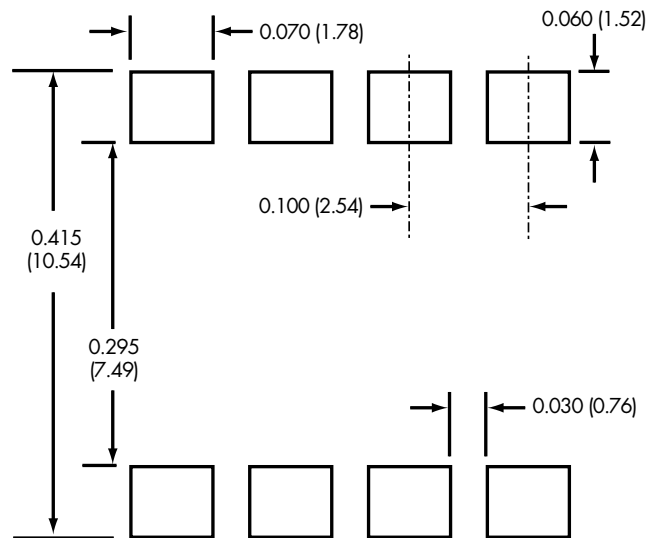

## 6-Pin Surface Mount Dual In-line Package (Black)

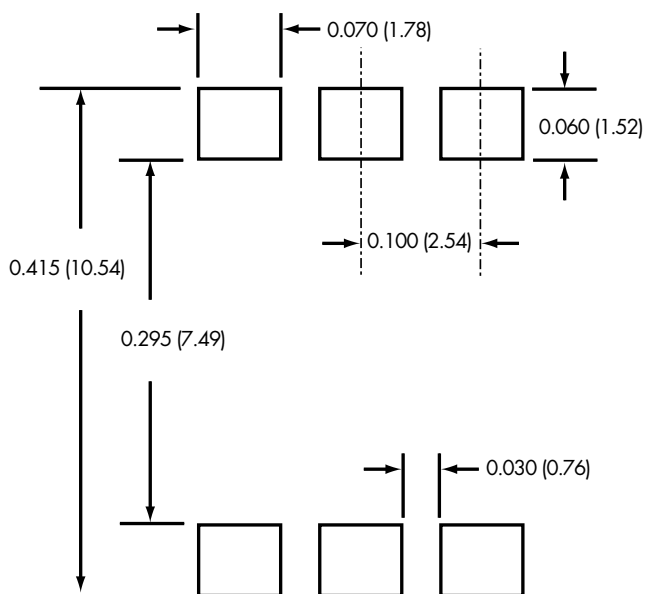

## 8-Pin Small Outline Package (White)

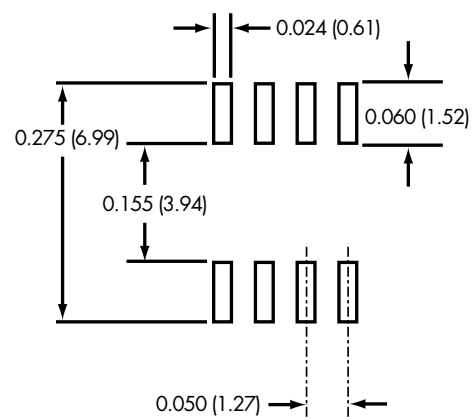

All dimensions are in inches (millimeters)